

[주]미라클산업
TEL: 02-2643-7033/4
FAX: 02-2643-7035
email: miracle@miracleits.com
web: www.miracleits.com

Miracle
주식회사미라클산업

Enhanced Road Safety
Lighting Collection
Solar Powered Lighting

INNOBIZ
기술혁신영증소기업



Ver. 2020/2021

CONTACT



□ 본사/공장
서울 강서구 허준로 217 가양테크노타운 301
TEL : 02-2643-7033/4
FAX : 02-2643-7035
Http : //www.miracleits.com
E-mail : miracle@miracleits.com

□ Head Office / Factory
#301, Gayang Techno-town, 217 Heojun-ro,
Gangseo-gu, Seoul, Korea
TEL : +82-2-2643-7033/4
FAX : +82-2-2643-7035
Http : //www.miracleits.com
E-mail : miracle@miracleits.com

CONTENTS

·회사소개	04
·도로안전	
·활주로형 횡단 보도유도등	08
·도로표지병	12
·터널 시선유도등	24
·경고등	28
·발광형 교통표지	34
·과속경보 시스템	36
·가변형 교통안전표지	38
·안개경보 시스템	40
·도로기상 정보시스템	44
·경관조명	
·태양광 조명블럭	50
·태양광 매입등	58
·태양광 난간등	64
·태양광 LED 바	68
·태양광 스텝등	72
·태양광 가로등	74
·LED 가로등	78
·LED 투광등/보안등/공장등	80
·CC 카메라	82

회사 소개

Our History



2000 ~

- 2000 (주)미라클산업 법인설립
조달 우수제품 인증-조달청
건설신기술 제162호인증-건설교통부
- 2001 기술혁신형 중소기업인증
- 2002 자체발광형 도로표지병 특허 등록
- 2003 미국특허, 의장권 인증
- 2005 태양광 경관조명 특허 및 상용화
- 2006 ISO9001/ISO14001 인증
- 2007 유럽TUV 인증
- 2008 안개경보등 특허 및 상용화
- 2009 LED 가로등 특허등록
금속구조 상호공사업 등록
- 2010 도로기상 정보시스템 특허 등록



2011 ~

- 2019~ 현재
정보통신 공사업 등록
활주로형 횡단보도 유도등 특허 등록
- 2018 CE 인증 MS127, MS110 시리즈
- 2017 가변형 교통표지 개발 완료
- 2016 조명전시회참가 - 중동두바이
CE 인증 MS708 시리즈
- 2015 병역 특례업체 지정-병무청
영종대교 안개 경보등 시공
사우디 AL RASHID MOU 체결
- 2014 원통형 태양광 가로등 특허 등록
- 2013 해외 조달시장 PQ 기업 인증-조달청
CE 인증-LED 가로등
- 2012 옥외광고업 등록
- 2011 수출유망 중소기업 인증
기업부설 연구소 설립
안개센서 공급권 획득-스웨덴



CE인증 (LED가로등) CE인증 (도로표지병) ISO 9001 ISO 14001 고효율 제품인증 신기술지정증서

우수제품인증서 벤처기업확인서 특허 (China) (Patent Certificate for Design) 해외조달시장 PQ 기업지정서 SAAO-COC (사우디아라비아 SASO인증) 특허증 (원통형 태양광 가로등)

특허증 (자체발광형 도로표지병) 특허증 (LED 조명등 및 이에 이용되는 방열유닛) 특허증 (LED 조명등) 특허증 (LED 조명등) 특허증 (발광다이오드 모듈 및 그 제조방법) 특허증 (도로 기상 종합 시스템 및 제공방법)

독일 TUV 인증서 US 6,602,021 B1 US D470,787S US D472,489S 이스라엘 인증서 호주인증서

도로 안전

Enhanced Road Safety



도로 안전

Enhanced Road Safety



MS-125CR

도로 표지병 [활주로형 횡단보도 유도등]

Crosswalk Runway Road Stud

□ G2B 식별번호

• 백색 /MS-125CR	• 23433097
----------------	------------



- MS-125CR
- LED 색상 : 백색 /White



□ 시공 / Install

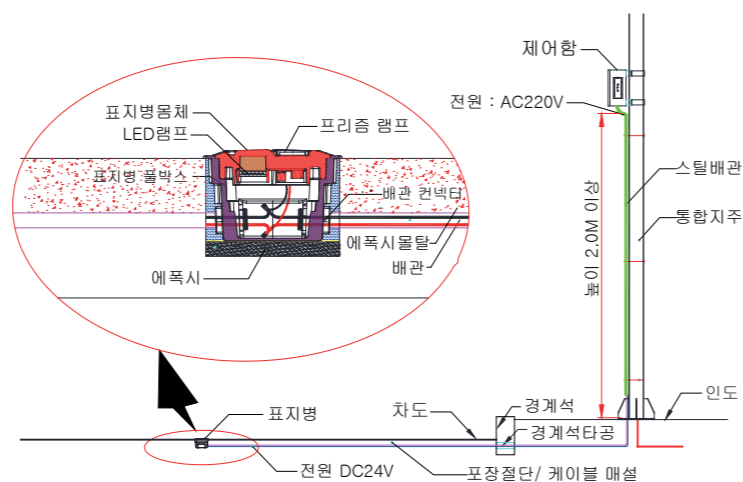
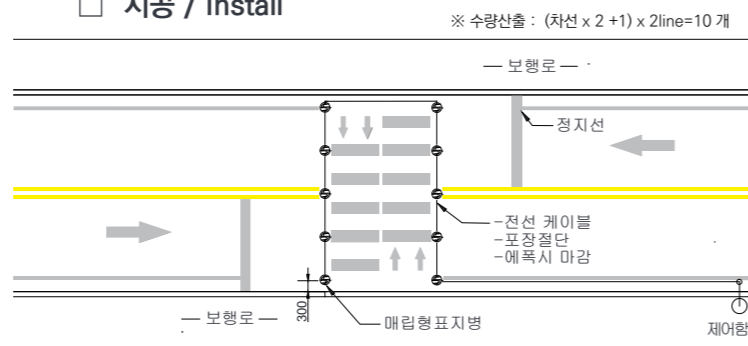

□ 도면 / CAD

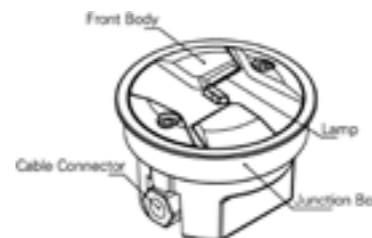
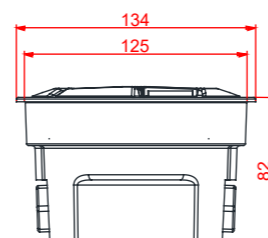
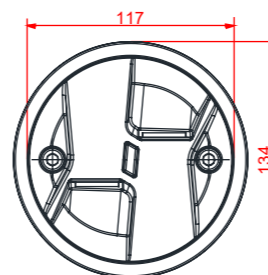

• 외형 / Type

□ 규격 / Specification

* 모델 Model	MS-125CR
* 크기 Size	Ø134 × H82mm
* 무게 Weight	±2.2Kg /Body
* 재료 Material	Body : AL - Alloy,
* 방수 W-proof	IP 68
* 색상 Color	Red. Blue. Green. Yellow. White.
* 램프 Lamp	Power LED Lamp (Cree Chip)
* 전원 Power	DC 24V/≤2.0W
* 밝기 luminosity	5000 mcd
* 인증 Test	도로안전시설 설치 및 지침



□ 옵션 / Options



- 2구 양면 (기본) MS-125CR
- 4구 양면 발광 MS-125-2CR
- 4구 4면 발광 MS-125-4CR

□ 적용 / Application

- * 횡단보도
- * 어린이 보호구역
- * 차선표시 및 안내
- * 중앙선, 사고 위험지역
- * 자전거로,보행자로
- * 안전지대, 진/출입로
- * 안개지역, 갓길
- * 인터체인지,
- * 공원,테마거리
- * Crosswalk.
- * School Zone
- * Lane Marking, Guidance
- * Accident prone locations
- * Hazard marking
- * Delineation for bicycle
- * Pedestrian trails
- * Fog hazard areas.
- * Shoulder, Curves
- * Design theme park.

MS125CR-A

유도등 제어기 (MS125CR-A)

Crosswalk Road Stud Controller

□ G2B 식별번호

• MS125CR-A (조명용 제어기)	23974973
--------------------------	----------

□ 외형



• 제어기 /MS125CR-A



□ 시공 / Install



□ 도면 / CAD

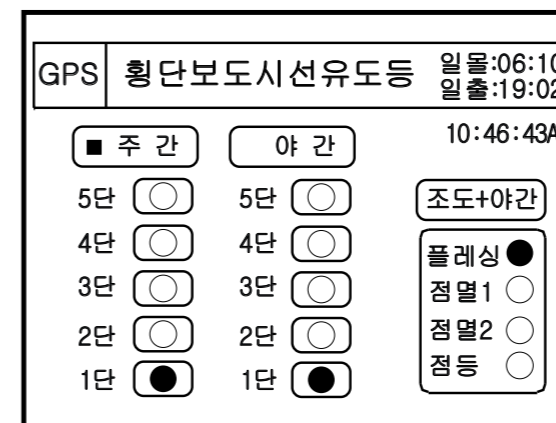
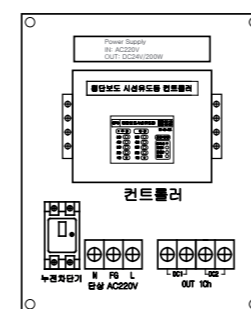
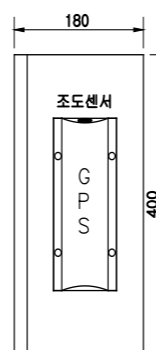

• 제어기 LCD 터치 패널

□ 규격 / Specification

* 모델 Model	MS125CR-A
* 크기 Size	D300 × H400 × H180
* 무게 Weight	±10.0Kg /Body : STS
* 출력 Output	PWM or PLC
* 제어 Control	32bit ARM Core-processor
* 조작 Operating	3.5 inch TFT LCD Touch Panel
* 전원 Power	Input AC100~240V.60Hz Output : DC 12~24V
* 제어 Control	GPS /조도센서 /리모컨
* 특징 Feature	GPS.조도센서.디밍제어. 주간·야간 선택적 점등.점멸 정전보상.무선 리모컨 제어.

□ 기능 / Function

- * 주.야간 밝기 5단계 설정
- * GPS에 의한 주/야간 선택 점등
- * 조도센서 우선모드
- * 무선 리모컨 제어
- * LED 동작설정
 - 점등형모드
 - 플래싱: 스트로브 기능
 - 점멸1 : 1초 사이클 점멸
 - 점멸2 : 2초 사이클 점멸
- * The LV1 to LV5 of Day or night display
- * GPS time system by ambient lux and night time
- * Wireless control
- * Light Mode
 - Steady lighting
 - Flash : 1 blinking per sec
 - Blk 1 : 2 blinking per sec
 - Blk 2 : police lighting

□ 적용 / Application

- * LED 조명용 제어기
- * LED 도로표지병 제어기
- * LED 터널 시선유도등 제어기
- * LED Lighting Control
- * LED Road Stud Control
- * Tunnel Lighting Control



• 제어기

MS-127 D_{ouble}

도로 표지병

Solar Powered Road Stud

□ G2B 식별번호

• 백색 /MS-127DSW	• 22559128
• 황색 /MS-127DSY	• 22585065



• 황색 /MS-127DSY

□ 시공 / Install



- 코어드릴 125mm
- Core Drill 5 inch
- 에폭시 A+B
- EPOXY

□ 도면 / CAD

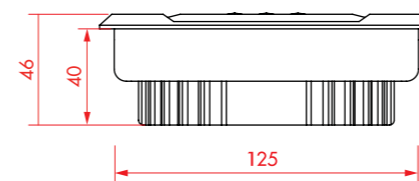
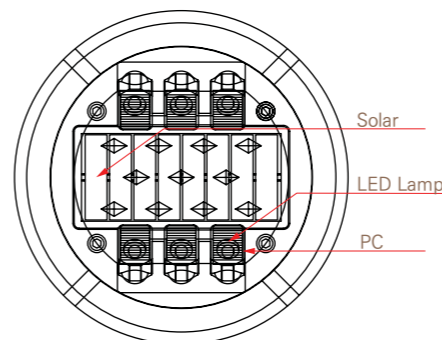

□ 규격 / Specification

* 모델 Model	MS-127
* 크기 Size	Ø125 × H40
* 무게 Weight	±800g
* 재료 Material	Body : AL - Alloy, Cover : PC
* 방수 W-proof	IP 68
* 색상 Color	Red. Blue. Green. Yellow. White.
* 램프 Lamp	LED Lamp
* 전원 Power	Solar Powered
* 점등 On/Off	250~300Lux
* 인증 Test	도로안전시설 설치 및 지침 .CE인증



□ 옵션 / Options

• LED색상.	Red. Blue. Green. Yellow. White.
• 점멸/점등.	Steady or Flashing Mode

□ 색상 / LED Color



RED

BLUE

YELLOW

GREEN

WHITE

□ 적용 / Application

- * 차선표시 및 안내
- * 중앙선, 사고 위험지역
- * 자전거로 및 보행자로
- * 안전지대, 진/출입로
- * 안개지역, 갓길
- * 인터체인지,
- * 공원, 테마거리
- * 야간 거리조명 조성
- * Lane Marking, Guidance
- * Accident prone locations
- * Hazard marking
- * Delineation for bicycle
- * Pedestrian trails
- * Fog hazard areas.
- * Shoulder, Curves
- * Design theme park.
- * Alternative to expensive street lighting



MS-110 Double

도로 표지병

Solar Powered Road Stud

□ G2B 식별번호

•백색 /MS-110DSW	•21285504
----------------	-----------



•백색 /MS-110DSW

□ 시공 / Install



- 코어드릴 110mm
- Core Drill 4 inch
- 에폭시 A+B
- EPOXY

□ 도면 / CAD

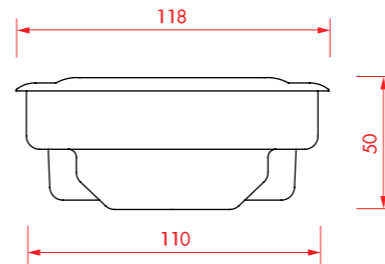
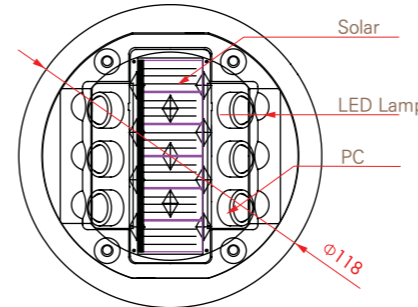

□ 규격 / Specification

* 모델 Model	MS-110
* 크기 Size	Ø110 × H50
* 무게 Weight	±500g
* 재료 Material	Body : AL - Alloy, Cover : PC
* 방수 W-proof	IP 68
* 색상 Color	Red. Blue. Green. Yellow. White.
* 램프 Lamp	LED Lamp
* 전원 Power	Solar Powered
* 점등 On/Off	250~300Lux
* 인증 Test	도로안전시설 설치 및 지침. CE인증



□ 옵션 / Options

* LED색상.	Red. Blue. Green. Yellow. White.
* 점멸/점등.	Steady or Flashing Mode

□ 색상 / LED Color



RED BLUE YELLOW GREEN WHITE

□ 적용 / Application

- * 차선표시 및 안내
- * 중앙선, 사고 위험지역
- * 자전거로 및 보행자로
- * 안전지대, 진/출입로
- * 안개지역, 갓길
- * 인터체인지,
- * 공원, 테마거리
- * 야간 거리조명 조성
- * Lane Marking, Guidance
- * Accident prone locations
- * Hazard marking
- * Delineation for bicycle
- * Pedestrian trails
- * Fog hazard areas.
- * Shoulder, Curves
- * Design theme park.
- * Alternative to expensive street lighting



MS-140 Double

도로 표지병

Solar Powered Road Stud

□ G2B 식별번호

•백색 /MS-140DSW	•21285505
----------------	-----------



•백색 /MS-140DSW

□ 시공 / Install



- 코아드릴 140mm
- 에폭시 A+B
- Core Drill 5.5 inch
- EPOXY

□ 도면 / CAD

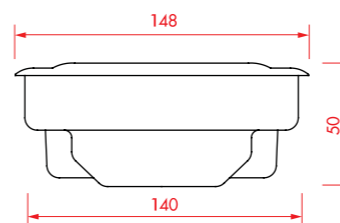
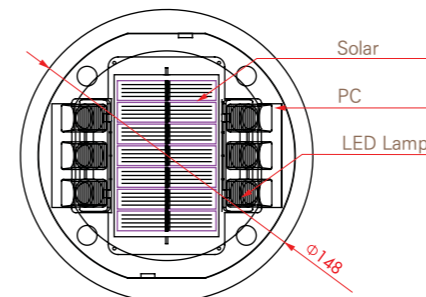

□ 규격 / Specification

* 모델 Model	MS-140
* 크기 Size	Ø140 × H50
* 무게 Weight	±820g
* 재료 Material	Body : AL-Alloy, Cover : PC
* 방수 W-proof	IP 68
* 색상 Color	Red. Blue. Green. Yellow. White.
* 램프 Lamp	LED Lamp
* 전원 Power	Solar Powered
* 점등 On/Off	250~300Lux
* 인증 Test	도로안전시설 설치 및 지침



□ 옵션 / Options

• LED색상.	Red. Blue. Green. Yellow. White.
• 점멸/점등.	Steady or Flashing Mode

□ 색상 / LED Color



□ 적용 / Application

- * 차선표시 및 안내
- * 중앙선, 사고 위험지역
- * 자전거로 및 보행자로
- * 안전지대, 진/출입로
- * 안개지역, 갓길
- * 인터체인지,
- * 공원,테마거리
- * 야간 거리조명 조성
- * Lane Marking, Guidance
- * Accident prone locations
- * Hazard marking
- * Delineation for bicycle
- * Pedestrian trails
- * Fog hazard areas.
- * Shoulder, Curves
- * Design theme park.
- * Alternative to expensive street lighting

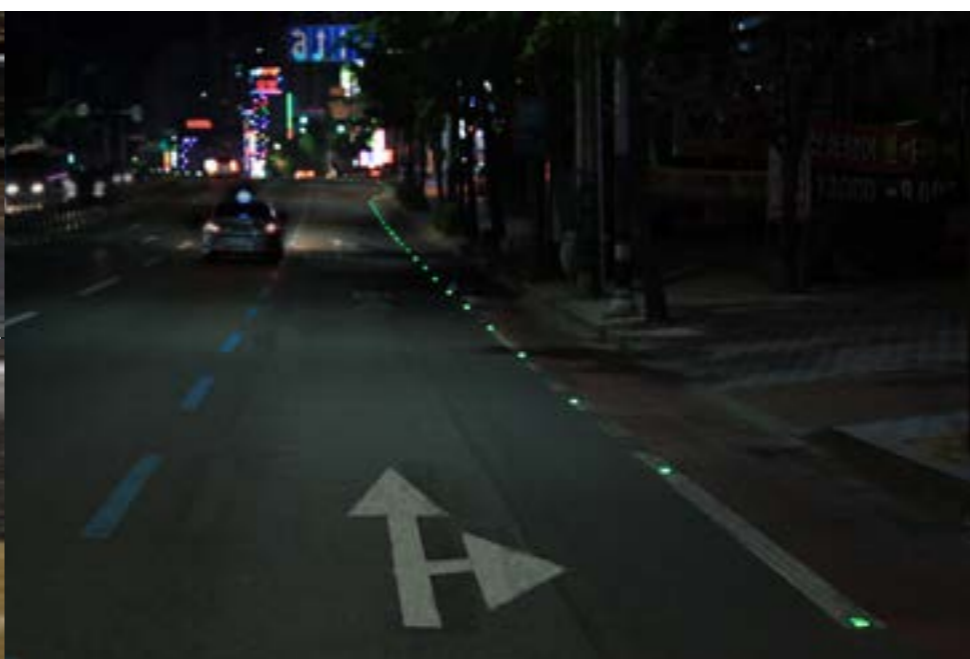

MS-200 Double

도로 표지병

Solar Powered Road Stud

□ G2B 식별번호

• 백색 /MS-200DSW	• 21285501
• 황색 /MS-200DSY	• 21285508



• MS-200DSY

□ 시공 / Install



- 햄머 드릴 32mm
- Hammer Drill



- 에폭시 A+B
- EPOXY

□ 색상 / LED Color



□ 도면 / CAD

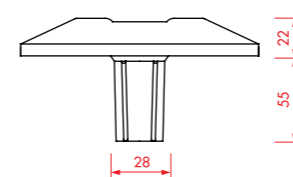
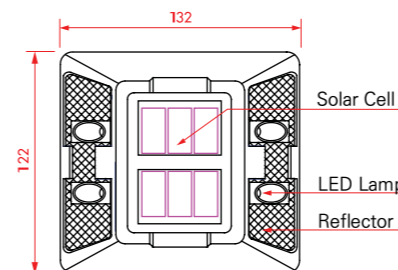

• 앵커형 / Anchor Type

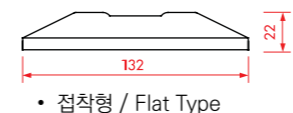

• 접착형 / Flat Type

□ 규격 / Specification

* 모델 Model	MS-200
* 크기 Size	앵커 Type (Anchor) : D132 * W122 * H77 플랫 Type (Flat) : D132 * W122 * H22
* 무게 Weight	±510g /Anchor. ±470g /Flat
* 재료 Material	Body : AL-Alloy, Cover : PC
* 방수 W-proof	IP 68
* 색상 Color	Red. Blue. Green. Yellow. White.
* 램프 Lamp	LED Lamp
* 전원 Power	Solar Powered
* 점등 On/Off	250~300Lux
* 인증 Test	도로안전시설 설치 및 지침



□ 옵션 / Options

* LED색상.	Red. Blue. Green. Yellow. White.
* 점멸/점등.	Steady or Flashing Mode

□ 적용 / Application

- * 차선표시 및 안내
- * 중앙선. 사고 위험지역
- * 자전거로 및 보행자로
- * 안전지대, 진/출입로
- * 안개지역. 갓길
- * 인터체인지,
- * 공원, 테마거리
- * 야간 거리조명 조성
- * Lane Marking, Guidance
- * Accident prone locations
- * Hazard marking
- * Delineation for bicycle
- * Pedestrian trails
- * Fog hazard areas.
- * Shoulder. Curves
- * Design theme park.
- * Alternative to expensive street lighting

MS-708 D_{ouble}

도로 표지병

Solar Powered Road Stud

□ G2B 식별번호

- 백색 /MS-708DSW
- 황색 /MS-708DSY



• MS-708 DSW

□ 시공 / Install



- 햄머 드릴 32mm
- Hammer Drill



- 에폭시 A+B
- EPOXY

□ 도면 / CAD

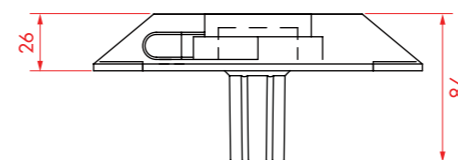
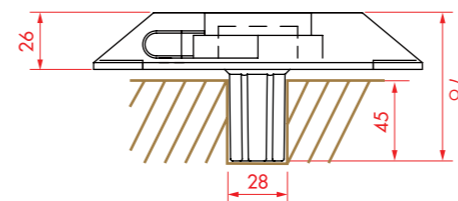

□ 규격 / Specification

* 모델 Model	MS-708
* 크기 Size	Ø145 × H22
* 무게 Weight	±650g
* 재료 Material	Body : AL - Alloy, Cover : PC
* 방수 W-proof	IP 68
* 색상 Color	Red. Blue. Green. Yellow. White.
* 램프 Lamp	LED Lamp
* 전원 Power	Solar Powered
* 점등 On/Off	250~300Lux
* 인증 Test	도로안전시설 설치 및 지침. CE인증



□ 옵션 / Options

* LED색상.	Red. Blue. Green. Yellow. White.
* 점멸/점등.	Steady or Flashing Mode

□ 색상 / LED Color



RED



BLUE



YELLOW



GREEN



WHITE

□ 적용 / Application

- * 차선표시 및 안내
- * 중앙선. 사고 위험지역
- * 자전거로 및 보행자로
- * 안전지대, 진/출입로
- * 안개지역. 갓길
- * 인터체인지,
- * 공원.테마거리
- * 야간 거리조명 조성
- * Lane Marking, Guidance
- * Accident prone locations
- * Hazard marking
- * Delineation for bicycle
- * Pedestrian trails
- * Fog hazard areas.
- * Shoulder. Curves
- * Design theme park.
- * Alternative to expensive street lighting

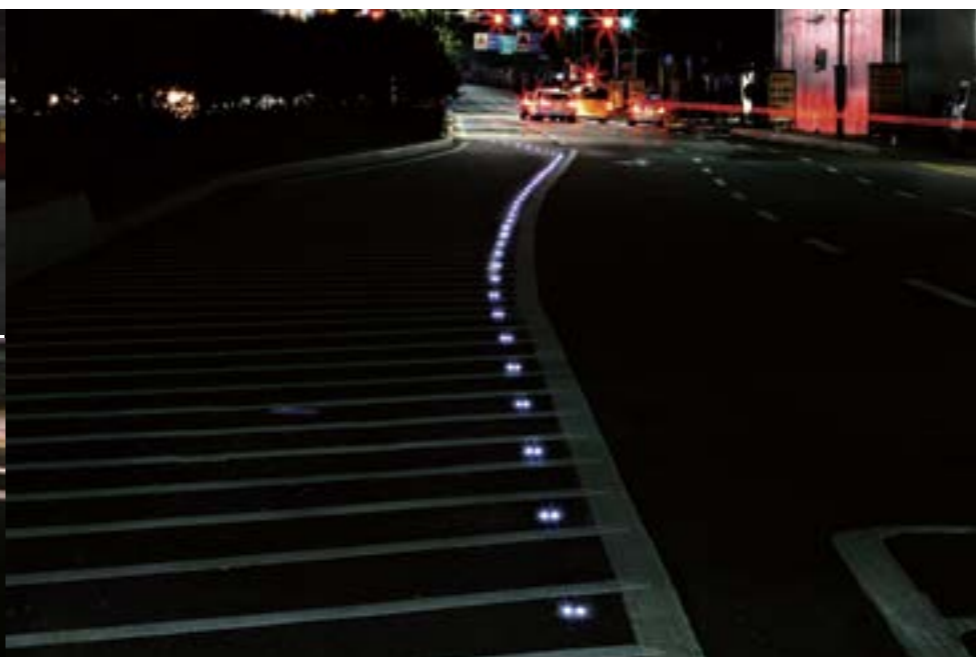

MS-100 Double

도로 표지병

Solar Powered Road Stud

□ G2B 식별번호

• 백색 /MS-100DSW	• 21285507
• 황색 /MS-100DSY	• 21285506



• MS-100 DSY

□ 색상 / LED Color



RED

BLUE

YELLOW

GREEN

WHITE

□ 도면 / CAD

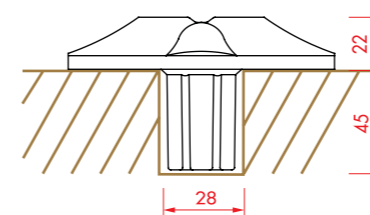
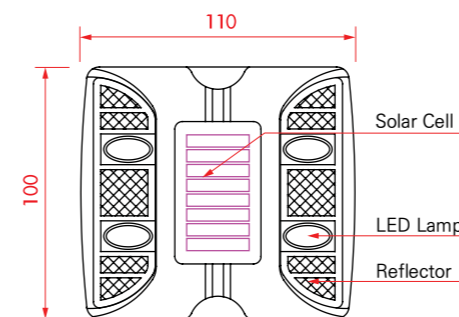

• 앵커형 / Anchor Type

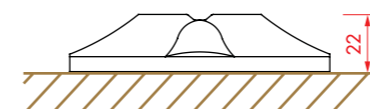

• 점착형 / Flat Type

□ 시공 / Install



- 햄머 드릴 32mm
- Hammer Drill

- 에폭시 A+B
- EPOXY

□ 규격 / Specification

* 모델 Model	MS-100
* 크기 Size	앵커 Type (Anchor) : D100 * W110 * H67 플랫 Type (Flat) : D100 * W110 * H22
* 무게 Weight	±360g /Anchor. ±300g /Flat
* 재료 Material	Body : AL-Alloy, Cover : PC
* 방수 W-proof	IP 68
* 색상 Color	Red. Blue. Green. Yellow. White.
* 램프 Lamp	LED Lamp
* 전원 Power	Solar Powered
* 점등 On/Off	250~300Lux
* 인증 Test	도로안전시설 설치 및 지침



□ 옵션 / Options

• LED색상.	Red. Blue. Green. Yellow. White.
• 점멸/점등.	Steady or Flashing Mode

□ 적용 / Application

- * 차선표시 및 안내
- * 중앙선. 사고 위험지역
- * 자전거로 및 보행자로
- * 안전지대, 진/출입로
- * 안개지역. 갓길
- * 인터체인지,
- * 공원. 테마거리
- * 야간 거리조명 조성
- * Lane Marking, Guidance
- * Accident prone locations
- * Hazard marking
- * Delineation for bicycle
- * Pedestrian trails
- * Fog hazard areas.
- * Shoulder. Curves
- * Design theme park.
- * Alternative to expensive street lighting



DK-7 Double 유도등 [터널 시선유도등] Delineator Light

□ G2B 식별번호

• 백색 /DK-7	• 23188295
------------	------------



- 백색/녹색 또는 황색/녹색
- White/Green or Yellow/Green

□ 적용 / Applications



- 백색/녹색, White/Green
- 황색/녹색, Yellow/Green

□ 시공 / Install



- 고정용 브라켓트
- Bracket



- 제어기
- Controller

□ 도면 / CAD

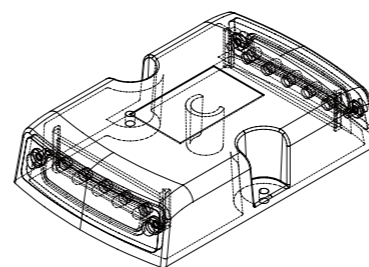
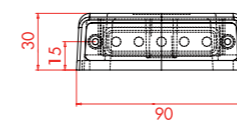
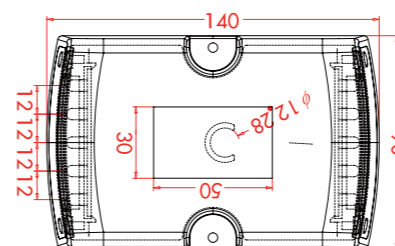

□ 규격 / Specification

* 모델 Model	DK-7
* 크기 Size	D90* W140 * H30
* 무게 Weight	±600g
* 재료 Material	Body : PC
* 방수 W-proof	IP 68
* 색상 Color	White-Green ,Yellow-Green
* 램프 Lamp	LED Lamp
* 전원 Power	16-24V/DC, ≤1.5W 무극성
* 점등 On/Off	제어기, PWM, PLC 제어
* 제어 Control	주야간 10단계, 터치스크린 제어



□ 옵션 / Options

• LED색상.	White-Green ,Yellow-Green
• 점멸/점등.	Steady or Flashing Mide

□ 적용 / Application

- * 터널측구, Tunnel Guidance
- * 사고 위험지역, Accident prone locations
- * 안전지대, 진/출입로, Hazard marking
- * 안개지역, 갓길, Pedestrian trails
- * 인터체인지, Fog hazard areas.
- * Shoulder, Curves, Shoulder. Curves

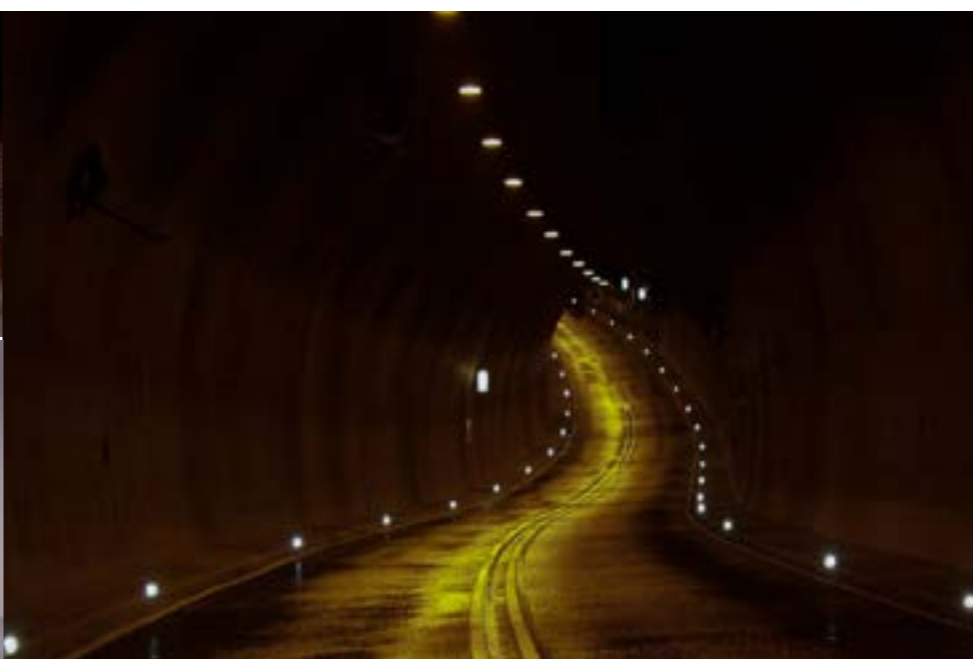

MS-125 DE

유도등 [터널 시선유도등]

Delineator Light

□ G2B 식별번호

• 백색 /MS-125DE	• 23555402
----------------	------------

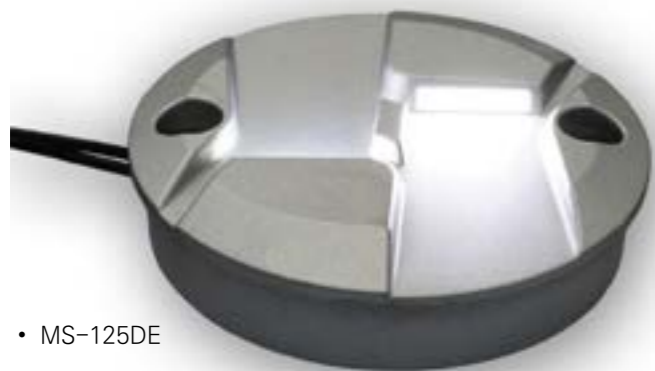

• MS-125DE

□ 적용 / Applications



□ 시공 / Install



• 고정용 브라켓트
• Bracket



• 제어기
• Controller

□ 도면 / CAD

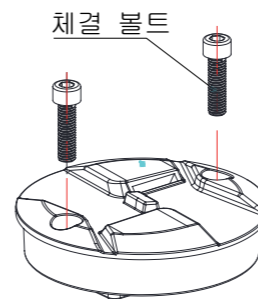
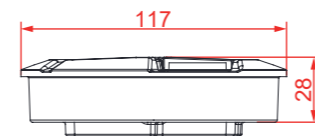
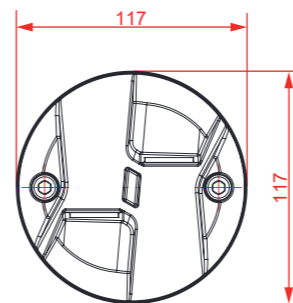

• 외형 / Type

□ 규격 / Specification

* 모델 Model	MS-125DE
* 크기 Size	Ø117 × H28
* 무게 Weight	±2.2Kg /Body
* 재료 Material	Body : AL-Alloy
* 방수 W-proof	IP 68
* 색상 Color	Red. Blue. Green. Yellow. White. RGB
* 램프 Lamp	LED Lamp
* 전원 Power	DC 24V
* 밝기 Brightness	5000 mcd
* 인증 Test	도로안전시설 설치 및 지침



□ 옵션 / Options

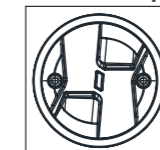

• 2구 양면 (기본)
• MS-125DE



• 4구 양면 발광
• MS-125-2DE



• 4구 4면 발광
• MS-125-4DE

□ 적용 / Application

- * 터널측구, Tunnel Guidance
- * 사고 위험지역, Accident prone locations
- * 안전지대, 진/출입로, Hazard marking
- * 안개지역, 갓길, Pedestrian trails
- * 인터체인지, Fog hazard areas.
- * Shoulder. Curves



MS-1140

슬라 경고등

Solar Warning Light

□ G2B 식별번호

• 황색 /MS-1140

• 22414192



□ 시공 / Install



- 고정용 브라켓트 지주
- Bracket Pole

□ 도면 / CAD

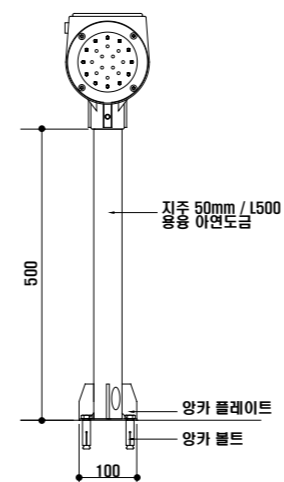
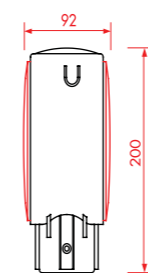
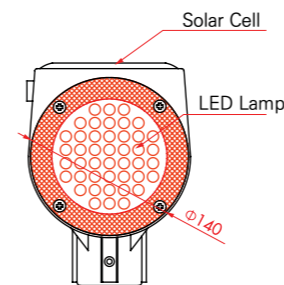

□ 규격 / Specification

* 모델 Model	MS-1140
* 크기 Size	Ø140 × W92 × H200
* 무게 Weight	±1.5Kg
* 재료 Material	Body : AL-Alloy, Cover : PC
* 방수 W-proof	IP 65
* 색상 Color	Yellow.
* 램프 Lamp	LED Lamp(12Hour)
* 전원 Power	Solar Powered
* 점등 On/Off	250~300Lux
* 제어 Controller	도로안전시설 설치 및 지침



□ 옵션 / Options

• LED색상.	LED Color
• 점멸/점등.	Steady or Flashing Mode

□ 적용 / Application

- * 사고 위험지역
- * 안전지대, 진/출입로
- * 안개지역, 갓길
- * 인터체인지,
- * Accident prone locations
- * Hazard marking
- * Pedestrian trails
- * Fog hazard areas.
- * Shoulder. Curves



- 슬라 확장형
- MS-1140



MS-3300

경고등

LED Warning Light

□ G2B 식별번호

• 황색 /MS-3300



• MS-3300

□ 설치용 암대 / Arm Bracket



□ 도면 / CAD

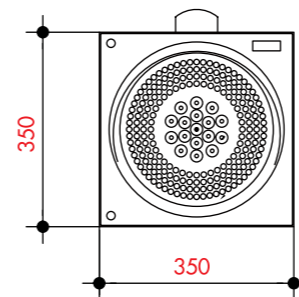

□ 시공 / Install



• 고정용 브라켓트 지주
• Bracket Pole

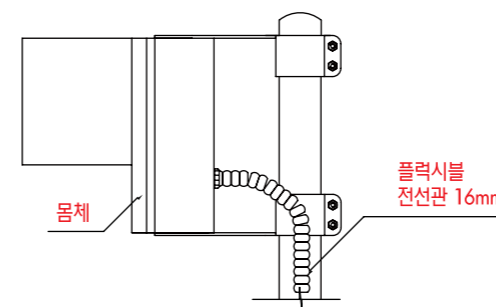

□ 규격 / Specification

* 모델 Model	MS-3300
* 크기 Size	D350 × H350 (3000)
* 무게 Weight	±5.0Kg
* 재료 Material	Body : PC
* 방수 W-proof	IP 65
* 색상 Color	Yellow.
* 램프 Lamp	LED Lamp
* 전원 Power	AC220V / ≤18.0W



□ 옵션 / Options

• LED색상.	LED Color
• 점멸/점등	Steady or Flashing Mode

□ 적용 / Application

- * 사고 위험지역
- * 안전지대, 진/출입로
- * 안개지역, 갓길
- * 인터체인지
- * 해안도로
- * Accident prone locations
- * Hazard marking
- * Pedestrian trails
- * Fog hazard areas
- * Shoulder. Curves



MS-3300-010,020

슬라 경고등

Solar LED Warning Light

□ G2B 식별번호

- 황색 /MS-3300-010
- 황색 /MS-3300-020

□ MS-3300-010



□ MS-3300-020

□ 시공 / Install



- 고정용 브라켓트 지주
- Bracket Pole

□ 도면 / CAD

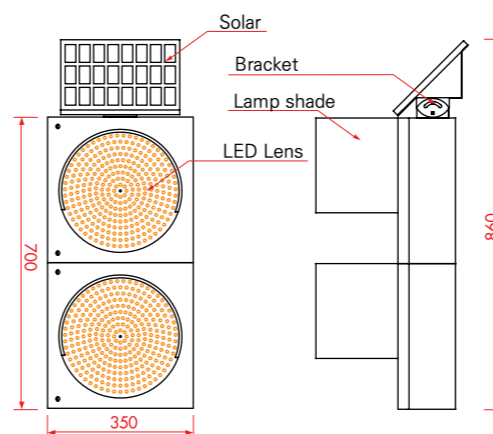
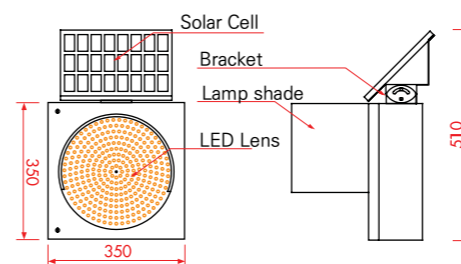

□ 규격 / Specification

* 모델 Model	MS-3300-010.	MS3300-020
* 크기 Size	D350 × H350	D350 × H700
* 무게 Weight	±8.0Kg	±15.0Kg
* 재료 Material	Body : PC	
* 방수 W-proof	IP 65	
* 색상 Color	Yellow.	
* 램프 Lamp	LED Lamp	
* 전원 Power	Solar Powered	
* 점등 On/Off	250~300Lux	
* 제어 Control	도로안전시설 설치 및 지침	



□ 옵션 / Options

• LED색상.	LED Color
• 점멸/점등.	Steady or Flashing Mode

□ 적용 / Application

- * 사고 위험지역
- * 안전지대, 진/출입로
- * 안개지역, 갓길
- * 인터체인지
- * Accident prone locations
- * Hazard marking
- * Pedestrian trails
- * Fog hazard areas.
- * Shoulder. Curves

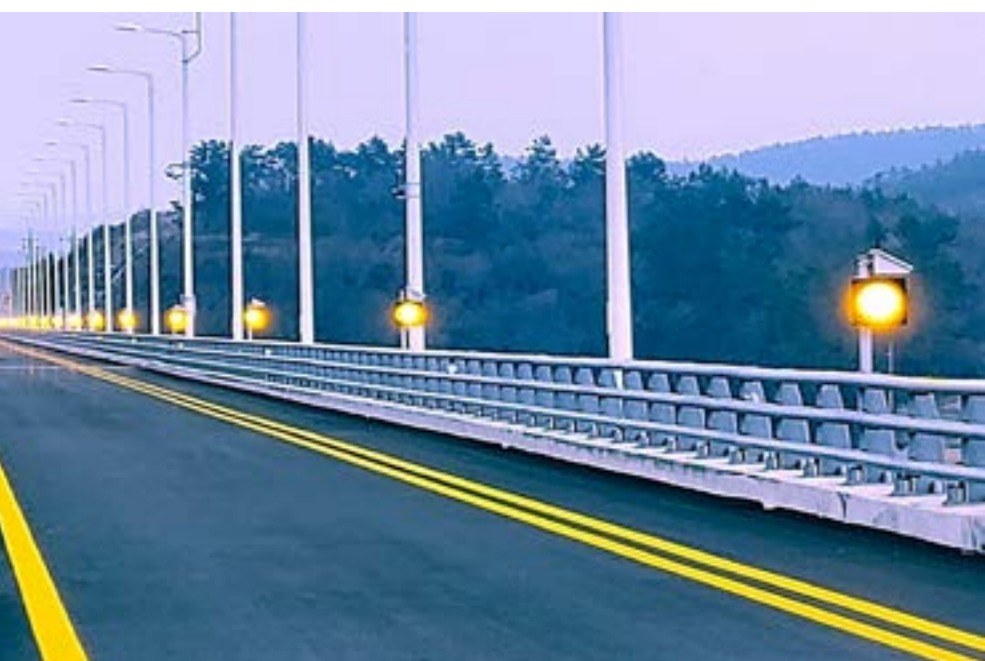

발광형 교통표지판

Solar Powered POF Traffic Signs

G2B 식별번호

•속도 /MST-SK80	•22432029
•좌로 /MST-JO1	•22433319



도면 / CAD

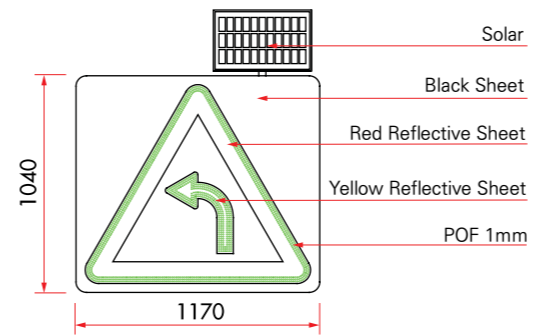
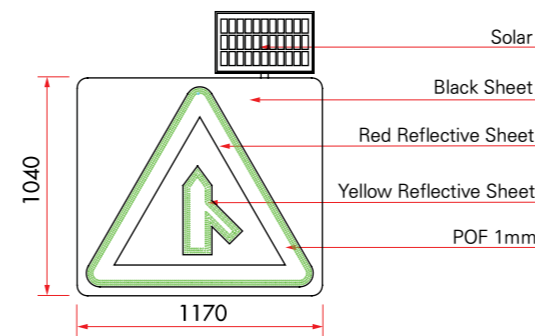
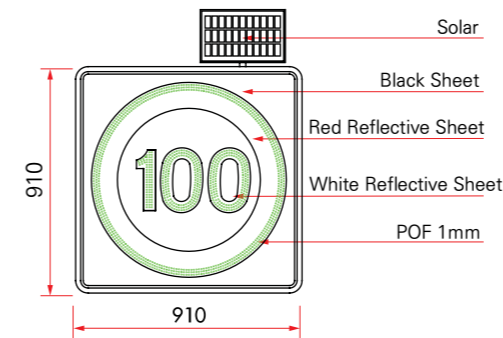

규격 / Specification

* 크기 Size	D910 × W910 × H60 D1170 × W1170 × H60
* 무게 Weight	±12.0Kg
* 재료 Material	Body : PC
* 방수 W-proof	IP 65
* 색상 Color	Green. Yellow. White.
* 램프 Lamp	LED Lamp
* 전원 Power	Solar Powered
* 점등 On/Off	250~300Lux
* 제어 Control	도로안전시설 설치 및 지침



옵션 / Options

• LED색상.	LED Color
• 점멸/점등.	Steady or Flashing Mode

적용 / Application

- * 사고 위험지역
- * 안전지대, 진/출입로
- * 안개지역, 갓길
- * 인터체인지,
- * Accident prone locations
- * Hazard marking
- * Pedestrian trails
- * Fog hazard areas.
- * Shoulder. Curves



과속주행 방지시스템 Driver Feedback Sign [DFS]

□ G2B 식별번호

•과속 방지 시스템 / DFS



□ 편지식



□ 단주식



□ 시공 / Install

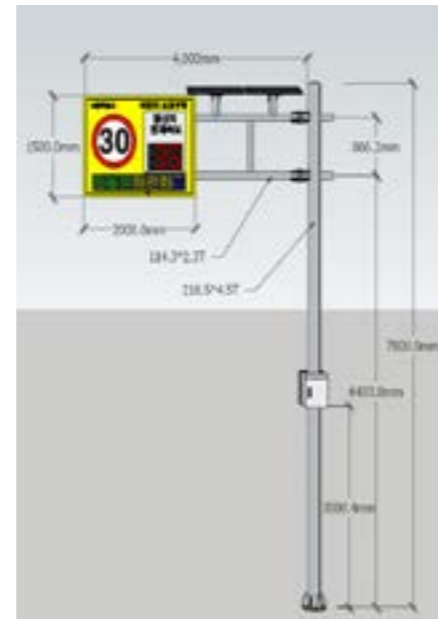

□ 도면 / CAD



□ 편지식



□ 단주식



□ 규격 / Specification

구분	단주식	편지식
*크기 (표지)	W900 × H2000mm 반사지 : 황, 백색 초고휘도	W2000 × H1500mm
*레이더 제어함	690 × 605 × 80mm	
*속도 검지기 센서	Rader k-밴드 24.15GHz	
*검지 범위	±150M	
*차량 속도	±10~300 Km/h	
*검지 영역	최대 4차선	
*LED 속도 표시부	7-SEGMENT Type 3Color (3자리 표시)	
*LED 정보 표시부	1800 × 360 × 110	
	모듈 : 3Color 240×240 (1단7열)	
*전원부(태양전지)	태양전지 : 100W	태양전지 : 200W
	축전지 : 12V/100A	축전지 : 12V /200A
	충전기 : 12V / 10A	
*지주	구조용 탄소강관 Ø114 × 4700mm	구조용 탄소강관 Ø216 × 7800mm Arm : 4000mm
	합체 : Steel 400*500*200.	
*인터페이스	RS232 / M2M LTE 모듈	
*원격감시 제어	장비 이상유무 및 제어 / 클라우드서버	

* 제조사양은 사용자의 요구에 의해 변경될 수 있음

□ 적용 / Application

- * 어린이 보호구역, School Zone
- * 사고 위험지역, Accident prone locations
- * 안개지역, 갓길, Fog hazard areas.
- * 인터체인지, Shoulder, Curves



가변형 교통안전표지 Variable Speed Limit [VSL]



□ 도면 / CAD

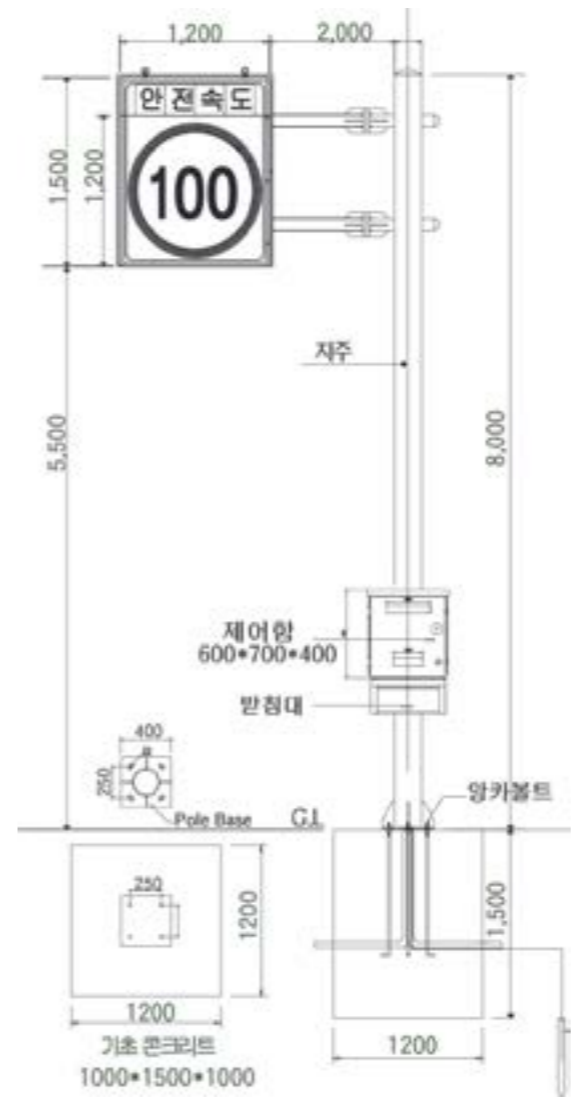

□ 규격 / Specification

구분	가변속도형	전광형(full Color)
* 표지 규격	표지 : 900 × 900 / 검정 무광도장 반사지 : 황.백색 초고휘도	
* 보조 표지 규격 LED Display	240 × 240 (16 Dot) 3Color 2단 2열	
* 속도 표지 LED Display	250 × 250mm white Color 2단 3열	300 × 300mm Full Color, 3단 3열
* LED 원형테두리	50 Red LED 740개	
* 조도 센서	범위: 0~10만Lux / 비시감곡선 8%	
* 밝기 제어	4~4만Lux - 20단계 이상조절(외부 조도 기준)	
* 통신 장치 인터페이스	RS-232/ LAN / LTE 무선통신	
* 컨트롤러	32bit micro processor	
* 전원 장치	Input (AC 90V~250V)	
* 설치방식	내민식 및 정주식	

* 제조사양은 사용자의 요구에 의해 변경될 수 있음

□ 옵션 / Options

* 표지규격종류	가변속도형 / 전광판형(full Color)
* 도로속도규격	B1=80~100km/h, B2=60~80km/h, B3=60km/h이하

□ 적용 / Application

- * 상습 안개지역
- * 상습 강우 또는 강설지역
- * 상습 결빙지역
- * 상습 교통 혼잡지역
- * 시간제 속도가변 지역
- * 어린이 보호구역
- * 노인 보호구역
- * Fog hazard areas.
- * Rainfall/Snowfall area
- * Ice on the road
- * Accident prone locations
- * Hazard marking
- * Pedestrian trails
- * school zone
- * silver zone

교통안전표지 종류		도로별 설치간격			자동차전용도로
		시도	지방도	자도	
최고속도 제한		규격(224)	200M	400M	800M
속도 제한 표시	100	80	50	30	폐쇄
	관심	주의	경계	심각	
강우	정상시	노면젖음	호우경보	호우(태풍)피해 발생(예상시)	
강설	정상시	2cm 미만	2cm 이상	-	10cm이상
강풍	정상시	14~20m/s	20~25m/s	-	20m/s이하
안개	정상시	250m이하	100m이하	50m이하	10m이하



안개경보 시스템

Fog Decection Warning System [FDWS]

안개경보시스템(FDWS)의 개요

안개경보시스템(FDWS)은 자동차의 안전운행을 방해하는 가장 큰 요소인 도로상의 안개지역을 사전에 감지하여 각종 경보시스템을 통해 운전자에게 전달함으로써 도로의 안전을 최대한 확보, 다중추돌 사고등을 미연에 방지할 수 있는 최첨단 도로안전 시스템입니다.

안개경보시스템(FDWS)의 특징

- ▶ 도로의 안개지역(안개상황)을 사전에 감지할 수 있습니다.
- ▶ 각종 경보시스템을 자동으로 가동시켜 도로안전을 확보합니다.
- ▶ 도로정보시스템에 각종 데이터 제공이 가능합니다.
- ▶ Solar cell방지(자가발전)을 통해 설치, 유지, 보수가 용이합니다.
- ▶ CDMA 방식을 이용, 운영자나 제조자가 원격관리 감독할 수 있습니다.

시스템 구성예시



▶ Optical Fog Sensor(OFS MK2)

안개센서는 레이저 빔을 조사하여 수분입자의 수를 파악하여 반사되는 광을 측정 연산하여 밀도/가시거리를 측정한다.

▶ Temperature / Humidity

대기 온도습도를 측정하여 안개가 발생하는 환경을 예측하며 안개와 온도습도를 대비하여 연산, 판단하도록 하는 센서이다.

▶ Data Logger Controller

사용하는 센서를 부착하여 프로토콜 하도록 하여 명령을 수행하는 컨트롤장치이다.

▶ Power Drive Controller

주 전원을 사용하도록 하는 계전기로서 상 전원을 위주로 사용시 경고등을 점멸하도록 하는 컨트롤 판넬이다.

▶ Wireless Data Transceiver

상 전원이 없는 곳에 무선컨트롤 하도록 하여 배신이 없이 경고등을 작동하도록 하는 무선 컨트롤 장치

▶ Solar Power Set

상 전원이 없는 곳에 설치하도록 하는 장치이며, 솔라판넬과 축전지로 구성된 시스템이다.

▶ Solar Warning Lighting Set

도로 주변에 다수의 경고등을 설치하여 운전자로 하여금 안전을 도모하는 안개유도등이다.

□ 도면 / CAD



• MS-3300-36

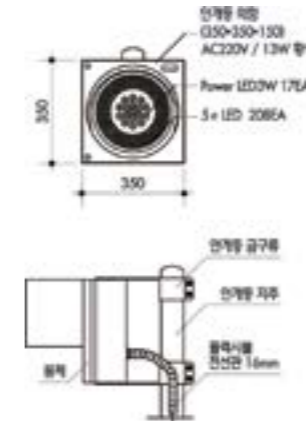

□ 규격 / Specification

* 모델 Model	MS-3300-36
* 크기 Size	D350 × W350 (Ø300)
* 무게 Weight	±5.0Kg
* 재료 Material	Body : PC
* 방수 W-proof	IP 65
* 색상 Color	Yellow.
* 전원 Power	AC220V /13W(Max)
* 광도 Candela	±90~3200 cd 시정거리에 따른 광도제어 방식
* 제어 Control	RS-485 통신 제어방식
* 시험 Test	국토교통부 시험기준에 의한 광도시험



• MS-3300RF

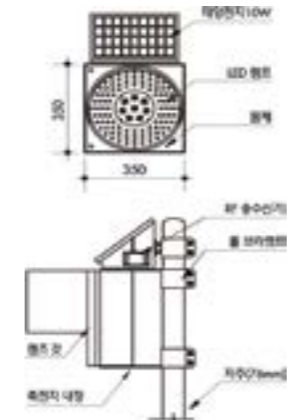

* 크기 Size	MS-3300RF
* 크기 Size	D350 × W350 (300)
* 무게 Weight	±8.0Kg
* 재료 Material	Body : PC
* 방수 W-proof	IP 65
* 색상 Color	Yellow LED Lamp
* 전원 Power	Solar 10W/13W(Max)
* 광도 Candela	±90~3200 cd 시정거리에 따른 광도제어 방식
* 제어 Control	RF424/Mhz 무선제어/
* 시험 Test	KAF-WDR-400/ KC인증 국토교통부 시험기준에 의한 광도시험



안개경보 시스템

Fog Decection Warning System [FDWS]

마스터 컨트롤러(MS-WDL-400)



■ 제품특징 / Features

분 류	사 양
크 기 (Size)	D280 • W240 • H160
CPU	32bit / 72hz
Monitor Screen	터치패널 3.5inch PFT LCD
아나로그	12ch
디지털 입출력	RS232, RS485, RF통신 LTE Lan 통신지원
기 능	가상센서에 의한 안개등 제어
재 질 (material)	Ploycarbonate Case
전 원 (Power)	DC12V / 200mA
KC인증 / 시험	MSIP-REM-Mir-MS-WDL400

옥외형 제어함



■ 제품특징 / Features

분 류	사 양
크 기 (Size)	H750 • W600 • D400
무 게 (Weight)	35kg
재 질 (Material)	SUS 304 1.5T / 분체도장
기 능	옥외 방수 및 분진 / 먼지에 의한 장비 보호
전 원 (Power)	Mccb, Elb, SPD, TB

RF중계기(MS-WDR-400)



■ 제품특징 / Features

분 류	사 양
크 기 (Size)	D210 • W150mm
무 게 (Weight)	1.5kg
재 질 (Material)	Polycarbonate / SUS304
기 능	RF 리피터 350m 연장용
전 원 (Power)	Solar Powered 6W
통신방식	RF 424Mhz 송수신
KC인증 / 시험	KAF-WDR-400 / 광도시험

원격제어 프로그램



■ 제품특징 / Features

분 류	사 양
해상도	1920 • 1080
통 신	CDMA / Lan 통신지원
제어 / 모니터링	안개등 실시간 모니터링 상태정보 표출 자동 및 수동제어
기 능	<ul style="list-style-type: none"> - 안개등 동작 그래픽 표출 - 시정데이터 그래프 지원 - 데이터 베이스 저장 - 수동 및 자동 제어 - log File 표출 - 통신 프로토콜 지원

485 중계기 (MS-WDR485)



■ 제품특징 / Features

분 류	사 양
크 기 (Size)	W300 • D300 • H200mm
무 게 (Weight)	1.6kg
재 질 (Material)	Ploycarbonate
기 능	안개등 제어 통신 RS-485 리피터 750m 연장용
전 원 (Power)	ACV 220V
통신방식	RS-485 분기용



도로기상 정보시스템

Road Weather Information System [RWIS]

도로기상정보시스템(RWIS) 개요

국지적 기상변화 및 기상상황을 모니터링 하여 실시간으로 정보제공을 하기 위한 시스템으로써, 여러 기상정보 수집기로부터 전송된 자료를 일반 기상정보와 안개에 의한 가시거리 관측정보등으로 가공하며, 돌발적인 기상변화에 대한 정보를 사전에 제공함으로써 운전자에게 편의를 제공하고 잠재적인 사고요인을 미연에 방지하기 위한 시스템이다

- ▶ 1분 간격으로 기상정보 데이터를 수집함으로써 실시간 기상정보 수집
- ▶ 풍향, 풍속, 강우량, 시정상태 정보를 실시간으로 수집하여 도로운영자 및 이용자에게 정보제공
- ▶ RWIS 수집자료를 DB로 구축
- ▶ 현장시스템의 상태정보를 수집하여 실시간으로 현장장비 모니터링
- ▶ 낙뢰로부터 시스템보호, 정전대비 배터리 Back-Up.
- ▶ 교통정보센터에서 현장시스템 원격제어
- ▶ 운전자의 운전상태를 고려하여 도로면으로부터 2M 이상의 높이에 시공.

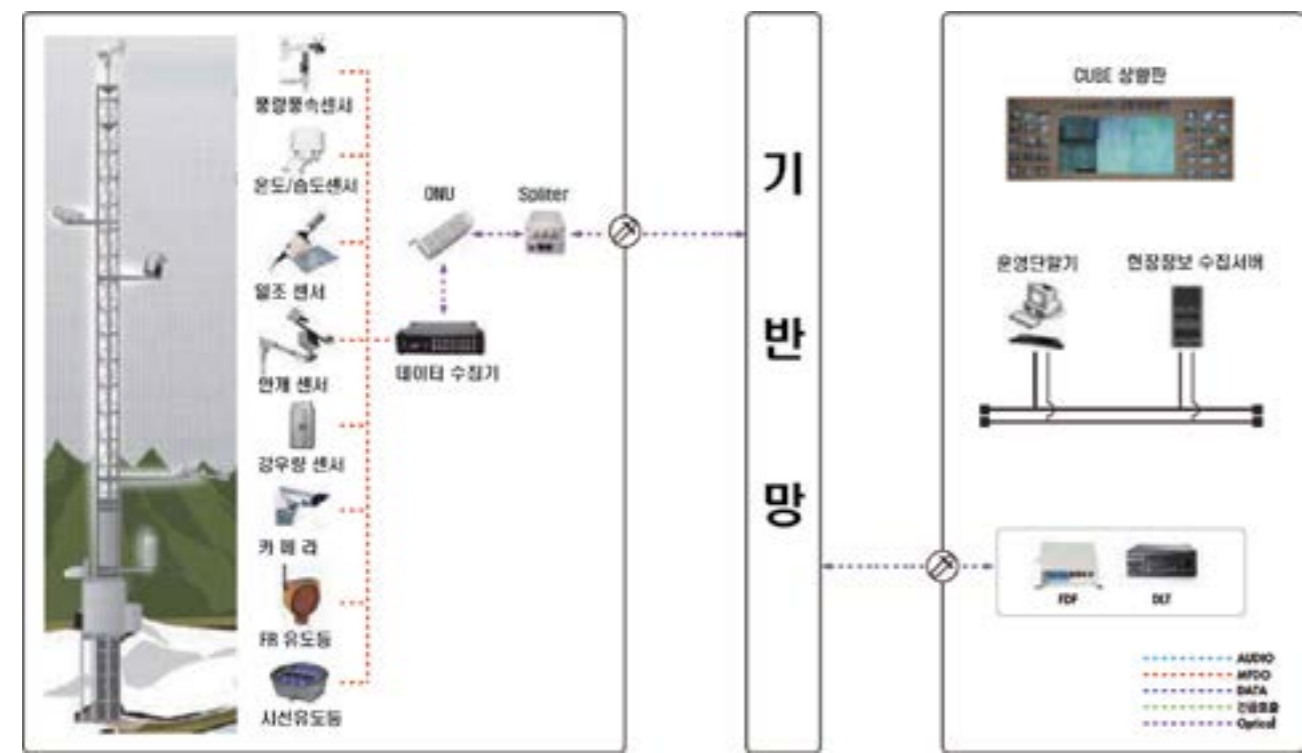

풍향/풍속센서
 - 측정방식 : 프로펠러형
 - 측정범위 : 0~355(풍향), 0~100m/s(풍속)
 - 정확도 : 3° (풍향), 0.3 m/s(풍속)
 - 기동풍속 : 1.1 m/s(풍향), 1.0 m/s(풍속)
 - 출력 : 저항, potentialmeter(풍향), 펄스(풍속)



시정계 (CS120A)
 - 측정방식 : forward scatter type
 - 측정범위 : Visibility 10~75km
 - 정확도 : ±10%, range 10 ... 10km
 ±15%, range 10 k... 15km
 ±20%, range 15 km 이상
 - 출력 : RS232, RS485
 - 전원 : 8~30VDC 히터: 24VDC/60W



온도/습도센서
 - 측정범위 : -80 ~ 60°C(온도), 0 ~ 100%(습도)
 - 정확도 : ±0.1 ~ 0.3 °C(온도), ±0.6 ~ 1%(습도)
 - 출력 : 0~1VDC
 - 41005-5 간이백업상(레디에이션 쉴드) 필요함



시정계 (PWD20)
 - 측정방식 : forward scatter type
 - 측정범위 : Visibility 10~20km
 - 정확도 : ±10%, range 10 ... 10km
 ±15%, range 10 ... 20km
 - 출력 : RS232 serial
 - 전원 : 220VAC



강우설량 센서
 - 측정방식 : Tipping bucket type
 - 정확도 : 3% 이내
 - 분해능 : 0.5mm
 - 수수구 직경 : 200mm
 - 출력 : Reed Switch
 - 히터 : 150W
 - 전원 : 110/220VAC



시정계 (Ofs Mk2)
 - 측정방식 : back scatter type
 - 측정범위 : Visibility 20~10km
 - 정확도 : ±10%, range 10 ... 5km
 ±20%, range 10 ... 10km
 - 출력 : RS232 serial
 - 전원 : 8~15VDC



도로노면센서 (매립형)
 - 측정범위 : Wet/damp/dry/snow /Ice
 - 노면온도 : -40°C~+80°C
 - 출력 : RS485
 - 전원 : 9~24Vdc



시정계 (mini PWS)
 - 측정방식 : back scatter type
 - 측정범위 : Visibility 20~5km
 - WMO Code : fog, Rain, Snow,
 - 정확도 : ±30%, range 10 ... 5km
 - 출력 : RS232 serial
 - 전원 : 8~15VDC



도로노면센서 (광학식)
 - 측정범위 : Dry/Ice/Wet/Snow /Forst
 - 노면온도 : -40°C~+80°C
 - 출력 : RS232 serial, 57600baud
 - 전원 : 8~15Vdc
 - 설치높이 : 10m



시정계 (mini Ofs)
 - 측정방식 : back scatter type
 - 측정범위 : Visibility 20~5km
 - 정확도 : ±30%, range 10 ... 5km
 - 출력 : RS232 serial
 - 전원 : 8~15VDC

도로기상 정보시스템

Road Weather Information System [RWIS]



■ 데이터 로거(CR800)

- ▶ 키보드 디스플레이가 없음
- ▶ 프로세서 : 16 bit
- ▶ 측정속도 : 100Hz
- ▶ 아날로그 입력채널 : 6개의 SE 채널 또는 3개의 Diff 채널
- ▶ A/D 컨버터 : 13 bit
- ▶ 동작온도 : -25 ~ 50°C 또는 -55 ~ 85°C(선택사항)
- ▶ 입력전압범위 : ±5,000mV
- ▶ 펄스신호 입력채널 : 2개
- ▶ 여기전압 공급채널 : 2개
- ▶ 컨트롤 포트(제어기능) : 4개
- ▶ 전력소모량 : 최대 27.6mA @100Hz 측정
- ▶ 통신 : 직접연결, CDMA, Ethernet, 전용선, RF무전기
- ▶ 제품특징: RS232 포트 기본 내장형 대용량 메모리2M flash(OS용), 4M SRAM(battery) 내장, 데이터로거 네트워크
- ▶ 응용분야 : 무인기상관측, 토목계측분야, 풍력 등 대체에너지 개발 대기오염 감시 농업기상연구, 수질, 수위 측정 등



■ 데이터 로거(CR1000)

- ▶ 프로세서 : 16 bit
- ▶ 측정속도 : 최대 100Hz
- ▶ 아날로그 입력채널 : 16개의 SE 채널, 8개의 Diff 채널
- ▶ A/D 컨버터 : 13 bit
- ▶ 동작온도 : -25 ~ 50°C 또는 -55 ~ 85°C(선택사항)
- ▶ 입력전압범위 : ±5,000mV
- ▶ 펄스신호 입력채널 : 2개
- ▶ 여기전압 공급채널 : 3개
- ▶ 컨트롤 포트(채널확장기 제어용) : 8개
- ▶ 전력소모량 : 최대 27.6mA @100Hz 측정
- ▶ 통신 : 직접연결, CDMA, Ethernet, 전용선, RF무전기, Bluetooth, 위성
- ▶ 제품특징: RS232 포트 기본 내장형 대용량 메모리(2M flash(OS용), 4M SRAM(battery 내장)), 데이터로거 네트워크
- ▶ 액세서리 : 컴팩트플래시 메모리 모듈, 아날로그 채널확장기, 외장형 키보드
- ▶ 응용분야 : 토목계측 및 구조물 모니터링 기상센서(온도, 습도, 풍향, 풍속 등)도 연결가능

■ 로거넷 프로그램

- ▶ 상급 수준의 데이터로거 운영 소프트웨어
- ▶ 각종 통신방식 설정 : 직접연결, 전화선, 전용선, CDMA, RF, Bluetooth, 위성 등
- ▶ 자동 데이터 수집 설정 및 유사시 알람 기능
- ▶ 수동 데이터 수집, 숫자 및 그래프의 실시간 모니터링, 로거 시간 설정 기능
- ▶ 모든 캠벨 데이터로거에 입력되는 구동 프로그램 제작 가능
 - 관측 간격과 통계처리 후 저장 간격 설정
 - 평균, 최고, 최저, 샘플, 윈드벡터, 적산 등 다양한 통계처리 지원
 - 사칙연산, 삼각함수, 지수, 로그, 이동평균, 공간평균 등 다양한 내부 연산 지원
- ▶ 복잡한 프로그램 제작 과정을 필요로 하지 않는 고객을 위한 "ShortCut" 기능
 - 전문가적인 코딩 작업이 필요 없이 간단하고 쉽게 구동 프로그램 제작이 가능
- ▶ 사용자가 직접 디자인이 가능한 화려한 실시간 모니터링 화면 제공
- ▶ 수집된 데이터의 2차 가공 기능
- ▶ 로거 대 로거 통신을 위한 네트워크 설정 기능

■ 환경제어컨트롤러

- ▶ 크 기 : L88 * W435 * D360
- ▶ 재 질 : Steel 분체도장
- ▶ C P U : 32Bit / Speed72Mhz
- ▶ Display : 3.5인치 TFT LCD 터치스크린
- ▶ IO port : 아날로그 16port / 디지털 4port
- ▶ 환경제어 : 온도습도센서 내장/Door 전후면 개폐상태, Fan 온도설정 / Heater 온도설정
- ▶ 통신 : RS232, 통신 Lan TCP/IP 프로토콜 제공



■ 옥외형 제어함

- ▶ 크 기 : L1000 * W600 * D600
- ▶ 재 질 : SUS 304 / 지정 분체도장
- ▶ 무 개 : 40kg
- ▶ 기능 : 옥외 방수 및 분진.먼지에 의한 장비 보호 히터, 펜, 양면 도어
- ▶ 전원단 : Elb, SPD, TB, Fan, Heater



■ 통합 자동화 운영 프로그램

- User Interface.
- ▶ DBMS 유지관리.
- ▶ C/S 기반의 프로그램.
- ▶ 통합관리프로그램 .
- ▶ 연계대상: 기상데이터, VMS, 안개시선유도등, 가변형교통 .전표지 등등.



경 관 조 명

Landscape Lighting



경 관 조 명

Landscape Lighting

MS-2200

태양광 조명블럭

Solar Lighting Brick

□ G2B 식별번호

• 단색 /MS-2200	• 20962214
• 혼색 /MS-2200	• 20962215

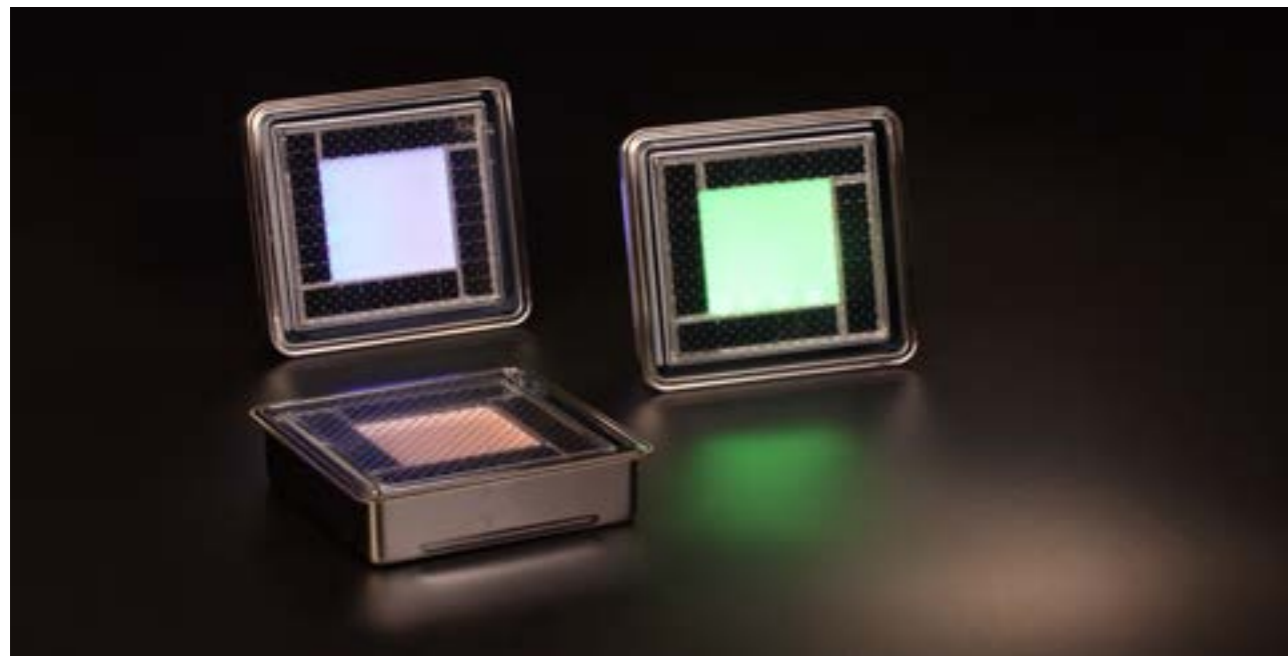

□ 색상 / LED Color

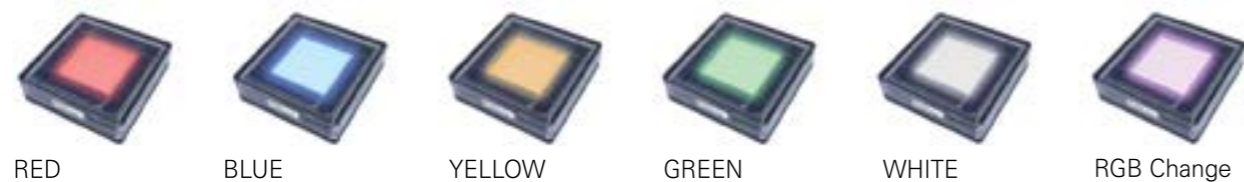

□ 도면 / CAD

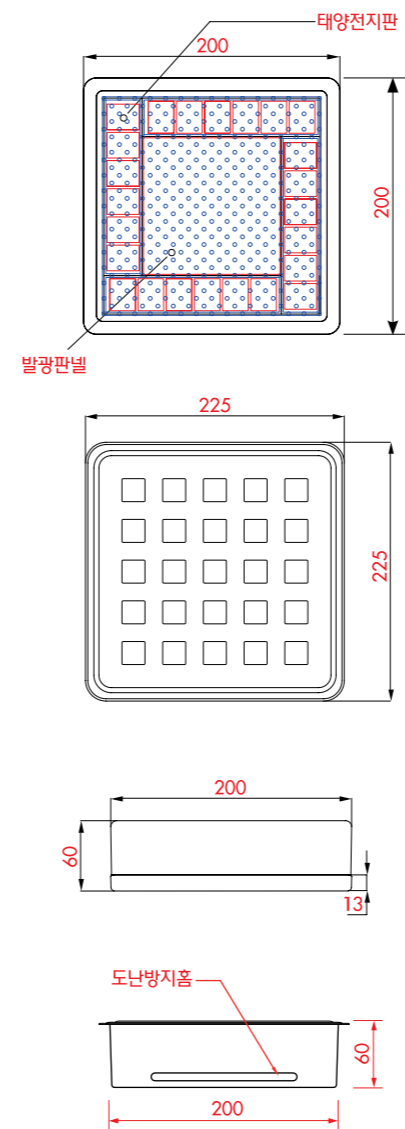

□ 규격 / Specification

* 모델 Model	MS-2200
* 크기 Size	D200 × W200 × H60
* 무게 Weight	±2.3g
* 재료 Material	Body : STS, PC
* 방수 W-proof	IP 68
* 색상 Color	Red. Blue. Green. Yellow. Yellow. Rgb
* 램프 Lamp	LED Lamp
* 전원 Power	Solar Powered
* 점등 On/Off	250~300Lux



□ 옵션 / Options

• LED색상.	LED Color
• 점멸/점등.	Steady or Flashing Mode

□ 적용 / Application

- * 광장 바닥조명
- * 데크로드
- * 산책로
- * 자전거로
- * 공원, 테마거리
- * 야간 거리조명 조성
- * Square ground Lighting
- * Deck Road
- * The walks in the area
- * Bike lane
- * Design theme park.
- * Alternative to expensive street lighting

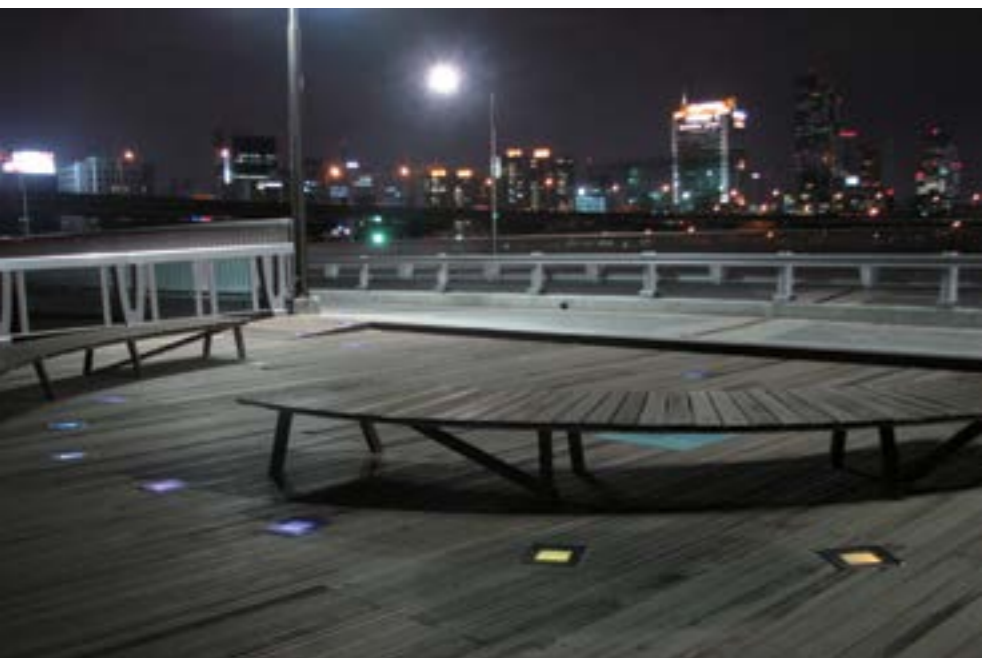

MS-2200 Full

태양광 조명블럭

Solar Lighting Brick

□ G2B 식별번호

• 단색 /MS-2200	• 20962214
• 혼색 /MS-2200	• 20962215

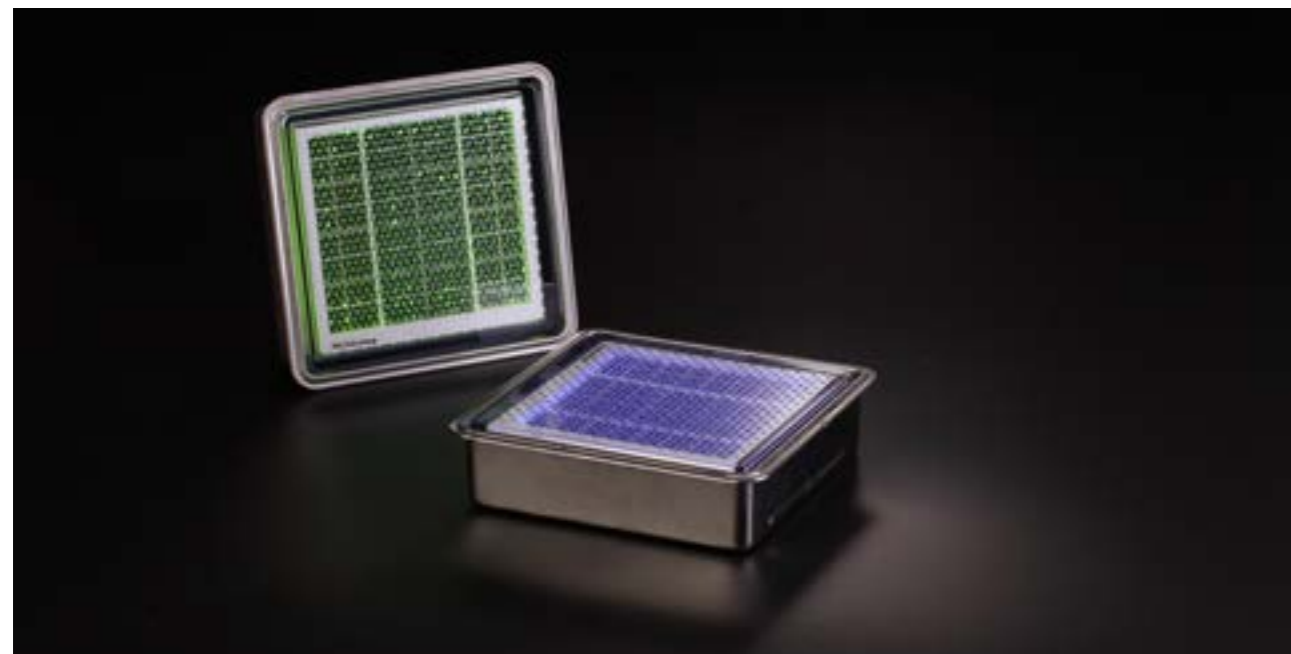

□ 색상 / LED Color

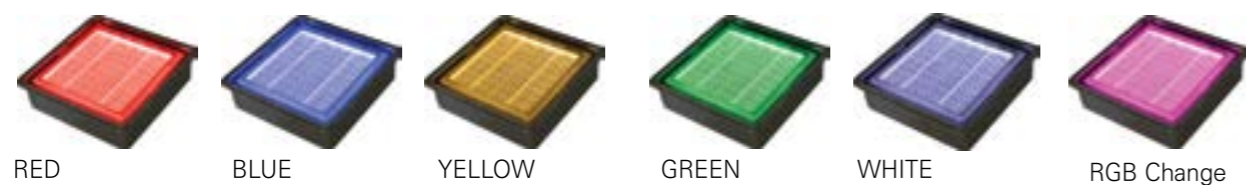

□ 도면 / CAD

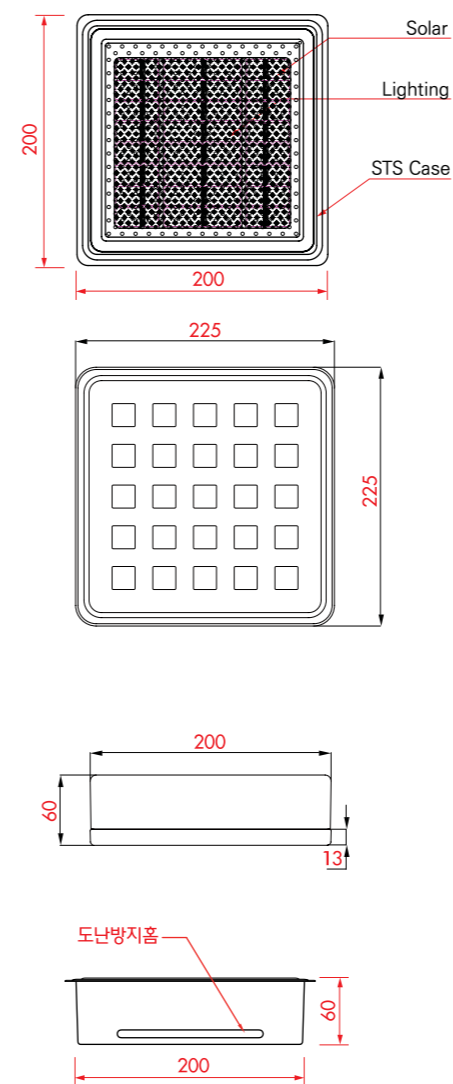

□ 규격 / Specification

* 모델 Model	MS-2200F
* 크기 Size	D200 × W200 × H60
* 무게 Weight	±2.3g
* 재료 Material	Body : PC,STS,
* 방수 W-proof	IP 68
* 색상 Color	Red. Blue. Green. Yellow. White.Rgb
* 램프 Lamp	LED Lamp
* 전원 Power	Solar Powered
* 점등 On/Off	250~300Lux



□ 옵션 / Options

• LED색상.	LED Color
• 점멸/ 점등.	Steady or Flashing Mode

□ 적용 / Application

- * 광장 바닥조명
- * 데크로드
- * 산책로
- * 자전거로
- * 공원.테마거리
- * 야간 거리조명 조성
- * Square ground Lighting
- * Deck Road
- * The walks in the area
- * Bike lane
- * Design theme park.
- * Alternative to expensive street lighting

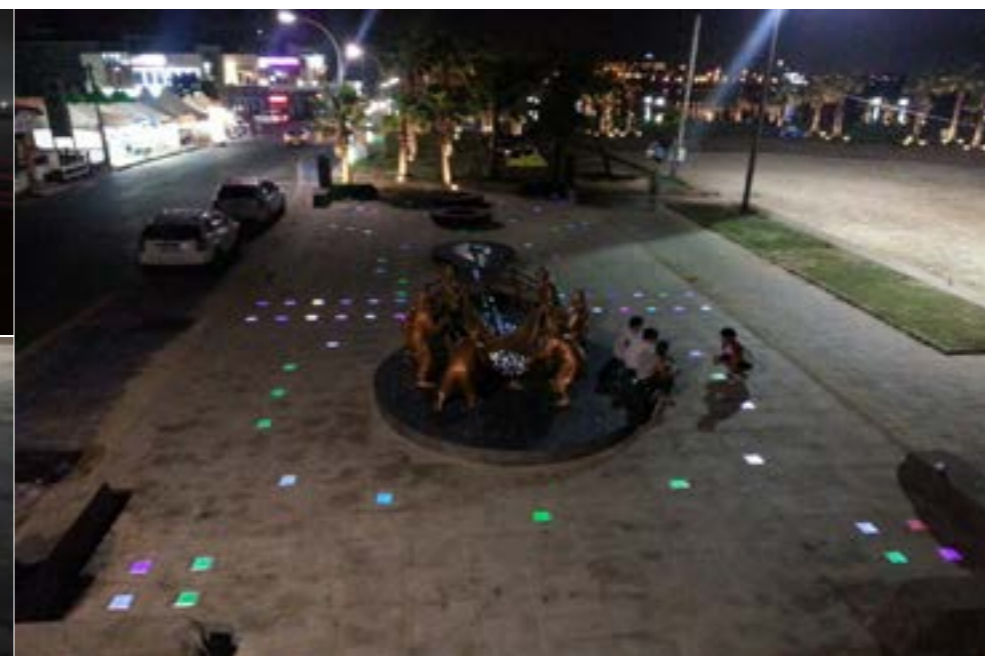
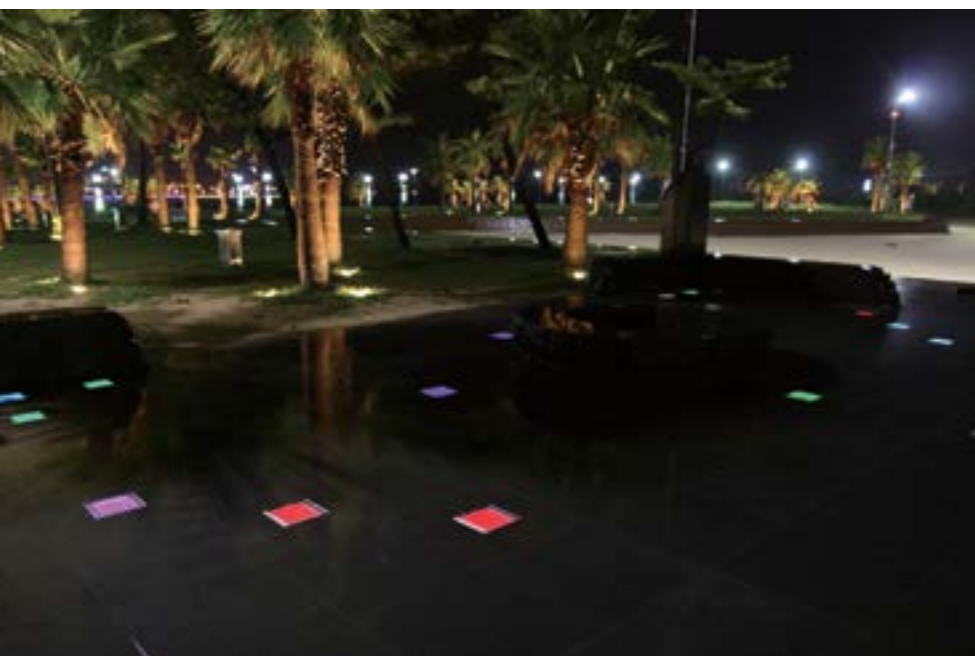

MS-2500

태양광 조명블럭

Solar Lighting Brick

□ G2B 식별번호

•단색 /MS-2500	•20409410
--------------	-----------



□ 색상 / LED Color

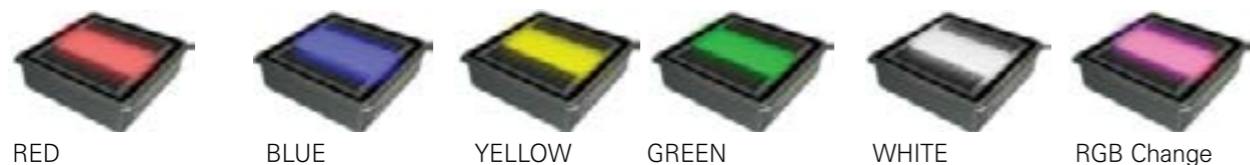

□ 도면 / CAD

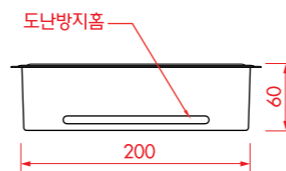
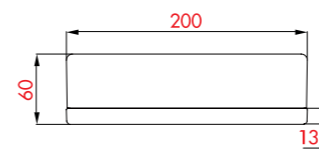
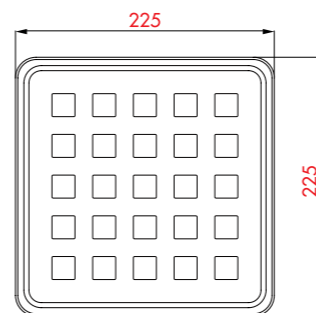
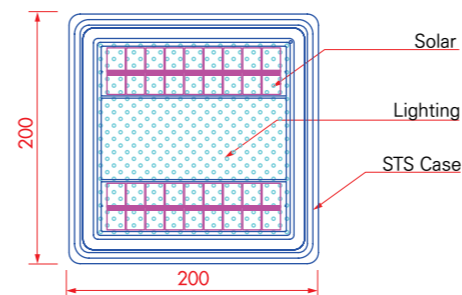

□ 규격 / Specification

* 모델 Model	MS-2500
* 크기 Size	D200 × W200 × H60
* 무게 Weight	±2.3g
* 재료 Material	Body : PC,STS,
* 방수 W-proof	IP 68
* 색상 Color	Red. Blue. Green. Yellow. White.Rgb
* 램프 Lamp	LED Lamp
* 전원 Power	Solar Powered
* 점등 On/Off	250~300Lux



□ 옵션 / Options

• 로고, 문구.	안내문자, TEXT
• 점멸/점등.	Steady or Flashing Mode

□ 적용 / Application

- * 정류장 표지
- * 주차금지 표지
- * 금연표지
- * 산책로 경로표지
- * 자전거로
- * 공원,테마거리
- * 야간 거리조명 조성
- * Bus Station
- * No Parking Sign
- * No Smoking Sign
- * Road way Sign
- * The walks in the area
- * Bike lane
- * Design theme park.
- * Alternative to expensive street lighting

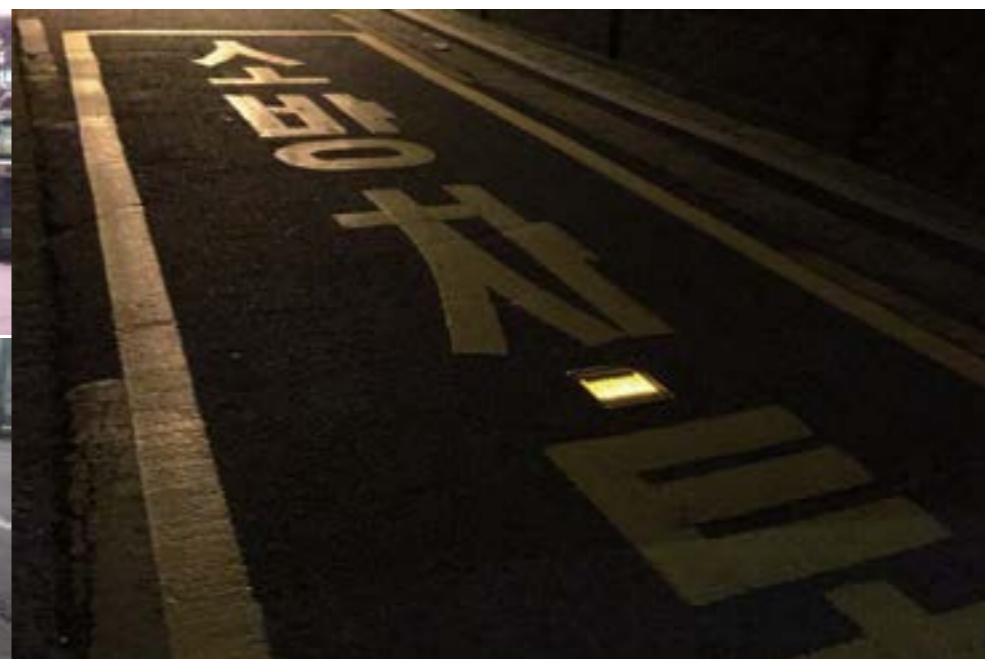

MS-2600

태양광 조명블럭

Solar Lighting Brick

□ G2B 식별번호

• 단색 /MS-2600	• 22409411
---------------	------------



□ 색상 / LED Color

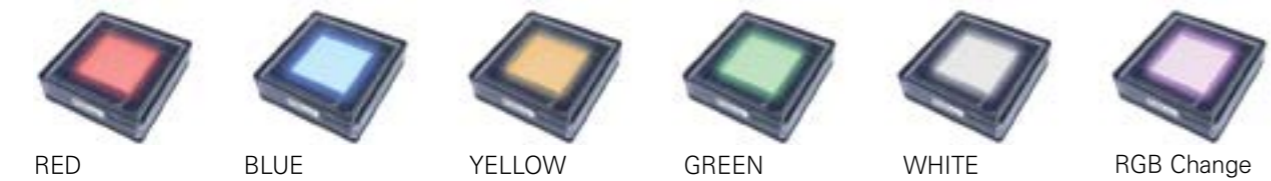

□ 도면 / CAD

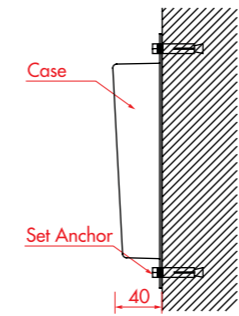
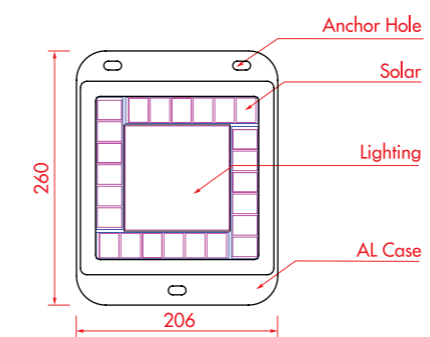

□ 규격 / Specification

* 모델 Model	MS-2600
* 크기 Size	D260 × W206 × H40
* 무게 Weight	±2.3g
* 재료 Material	Body : PC,STS,
* 방수 W-proof	IP 68
* 색상 Color	Red. Blue. Green. Yellow. White.Rgb
* 램프 Lamp	LED Lamp
* 전원 Power	Solar Powered
* 점등 On/Off	250~300Lux

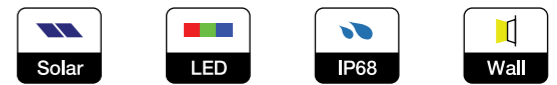

□ 옵션 / Options

• LED색상.	LED Color
• 점멸/점등.	Steady or Flashing Mode

□ 적용 / Application

- * 벽등
- * 산책로
- * 공원,테마거리
- * 야간 거리조명 조성
- * Wall Lighting
- * The walks in the area
- * Design theme park.
- * Alternative to expensive street lighting



MS-5030

태양광 매입등

Solar Under Ground Lighting

□ G2B 식별번호

• 단색 /MS-5030	• 21217398
---------------	------------



□ 색상 / LED Color



□ 도면 / CAD

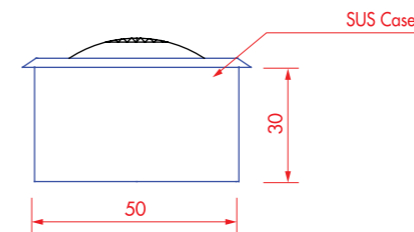
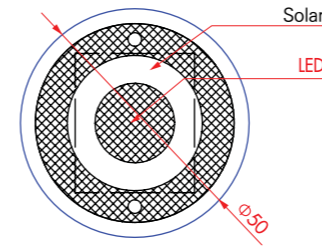

□ 규격 / Specification

* 모델 Model	MS-5030
* 크기 Size	Ø50 × H30
* 무게 Weight	±150g
* 재료 Material	Body : PC,STS,
* 방수 W-proof	IP 68
* 색상 Color	Red. Blue. Green. Yellow. White.
* 램프 Lamp	LED Lamp
* 전원 Power	Solar Powered
* 점등 On/Off	250~300Lux



□ 옵션 / Options

• LED색상.	LED Color
• 점멸/점등.	Steady or Flashing Mode

□ 적용 / Application

- * 별자리 조명
- * 산책로
- * 자전거로
- * 공원,테마거리
- * 야간 거리조명 조성
- * Constellation sign
- * The walks in the area
- * Bike lane
- * Design theme park.
- * Alternative to expensive street lighting



MS-6040

태양광 매입등

Solar Under Ground Lighting

□ G2B 식별번호

•단색 /MS-6040	•21787983
--------------	-----------



□ 색상 / LED Color



□ 도면 / CAD

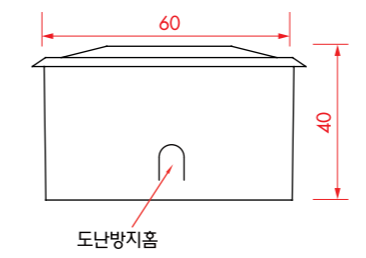
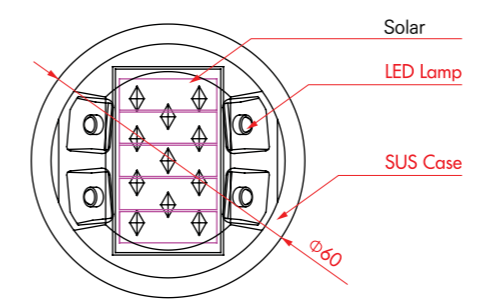

□ 규격 / Specification

* 모델 Model	MS-6040
* 크기 Size	Ø60 × H40
* 무게 Weight	±200g
* 재료 Material	Body : PC,STS,
* 방수 W-proof	IP 68
* 색상 Color	Red. Blue. Green. Yellow. White.
* 램프 Lamp	LED Lamp
* 전원 Power	Solar Powered
* 점등 On/Off	250~300Lux

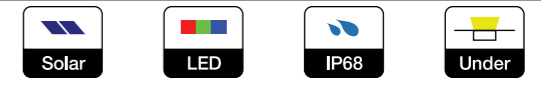

□ 옵션 / Options

• LED색상.	LED Color
• 점멸/점등.	Steady or Flashing Mode

□ 적용 / Application

- * 산책로
- * 자전거로
- * 공원,테마거리
- * 야간 거리조명 조성
- * The walks in the area
- * Bike lane
- * Design theme park.
- * Alternative to expensive street lighting



MS-1100

태양광 매입등

Solar Under Ground Lighting

□ G2B 식별번호

•단색 /MS-1100	•21787996
--------------	-----------



□ 색상 / LED Color



□ 도면 / CAD

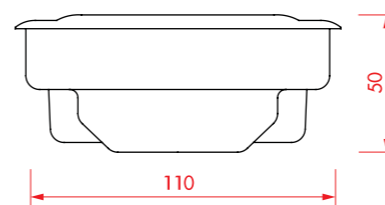
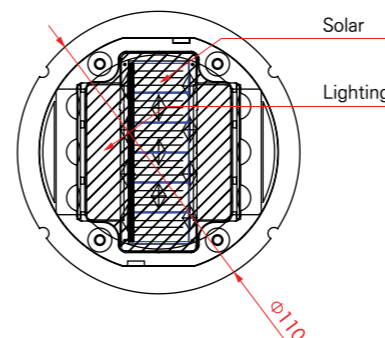

□ 규격 / Specification

* 모델 Model	MS-1100
* 크기 Size	Ø110 * H50
* 무게 Weight	±580g
* 재료 Material	Body : AL-Alloy, PC
* 방수 W-proof	IP 68
* 색상 Color	Red. Blue. Green. Yellow. White.Rgb
* 램프 Lamp	LED Lamp
* 전원 Power	Solar Powered
* 점등 On/Off	250~300Lux



□ 옵션 / Options

• LED색상.	LED Color
• 점멸/점등.	Steady or Flashing Mode

□ 적용 / Application

- * 산책로
- * 자전거로
- * 공원,테마거리
- * 야간 거리조명 조성
- * The walks in the area
- * Bike lane
- * Design theme park.
- * Alternative to expensive street lighting



MS-1060

태양광 난간캡등

Solar Cap Lighting

□ G2B 식별번호

• 단색 /MS-1060	• 22407115
---------------	------------



• MS-1060

□ 색상 / LED Color



Red /Blue /Yellow /Green /White

□ 시공 / Install



• 데크 난간
• Deck Cap

• 도면 / CAD

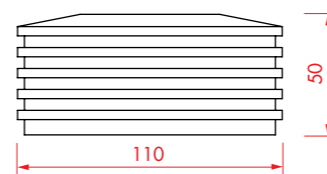
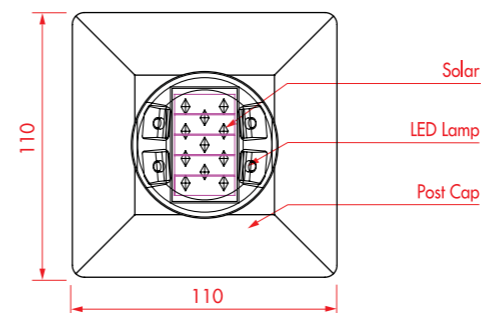

□ 규격 / Specification

* 모델 Model	MS-1060
* 크기 Size	D110 × H110
* 무게 Weight	±360g
* 재료 Material	Body : AL-Alloy, PC
* 방수 W-proof	IP 68
* 색상 Color	Red. Blue. Green. Yellow. White.
* 램프 Lamp	LED Lamp
* 전원 Power	Solar Powered
* 점등 On/Off	250~300Lux



□ 옵션 / Options

• 색상	Red. Blue. Green. Yellow. White.
• 크기(데크)	100.110.120.130mm

□ 적용 / Application

- * 난간펜스
- * 데크로드
- * 육교.다리
- * 산책로
- * 자전거로
- * 공원.테마거리
- * 야간 거리조명 조성
- * Fence Post
- * Deck Road post
- * bridge
- * The walks in the area
- * Bike lane
- * Design theme park.
- * Alternative to expensive street lighting

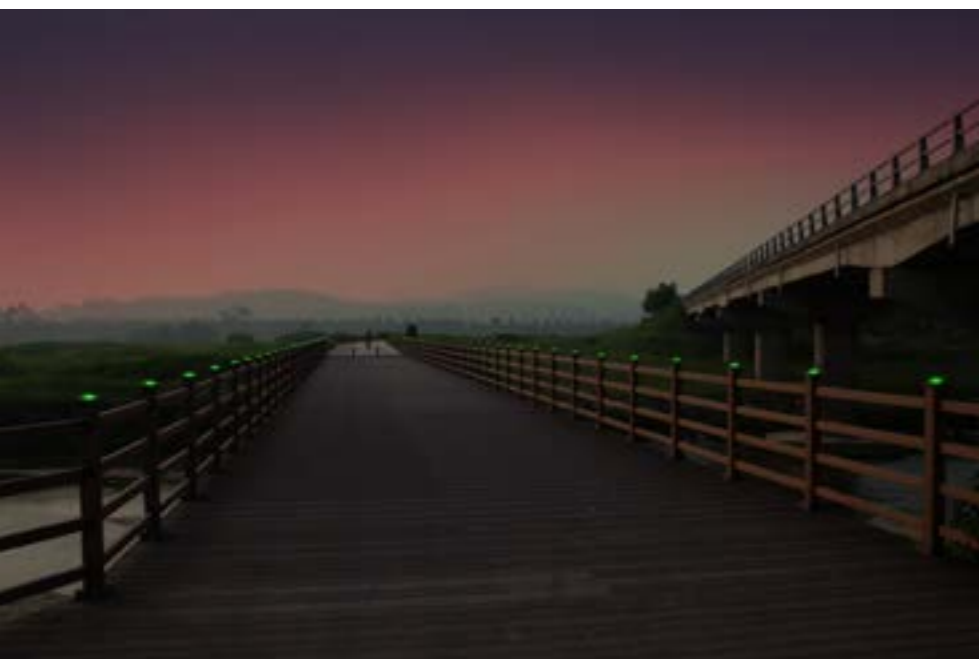

MS-1070

태양광 난간캡등

Solar Cap Lighting

□ G2B 식별번호

• 단색 /MS-1070	• 22407115
---------------	------------



• MS-1070

□ 시공 / Install



• 펜스 난간
• Fence Cap

□ 색상 / LED Color



• Red /Blue /Yellow /Green /White

□ 도면 / CAD

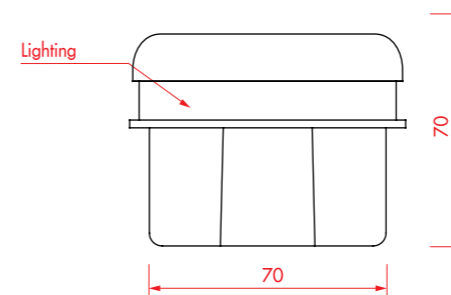
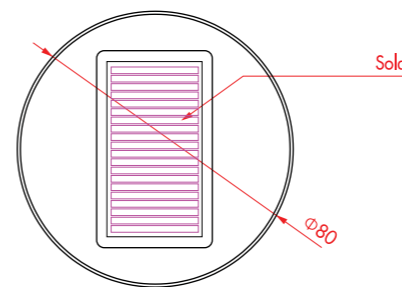

□ 규격 / Specification

* 모델 Model	MS-1070
* 크기 Size	Ø80 × H70
* 무게 Weight	±200g
* 재료 Material	Body : AL-Alloy, PC
* 방수 W-proof	IP 68
* 색상 Color	Red. Blue. Green. Yellow. White
* 램프 Lamp	LED Lamp
* 전원 Power	Solar Powered
* 점등 On/Off	250~300Lux



□ 옵션 / Options

• LED색상.	LED Color
• 점멸/점등.	Steady or Flashing Mode

□ 적용 / Application

- * 난간펜스
- * 육교.다리
- * 산책로
- * 자전거로
- * 공원.테마거리
- * 야간 거리조명 조성
- * Fence
- * bridge
- * The walks in the area
- * Bike lane
- * Design theme park.
- * Alternative to expensive street lighting

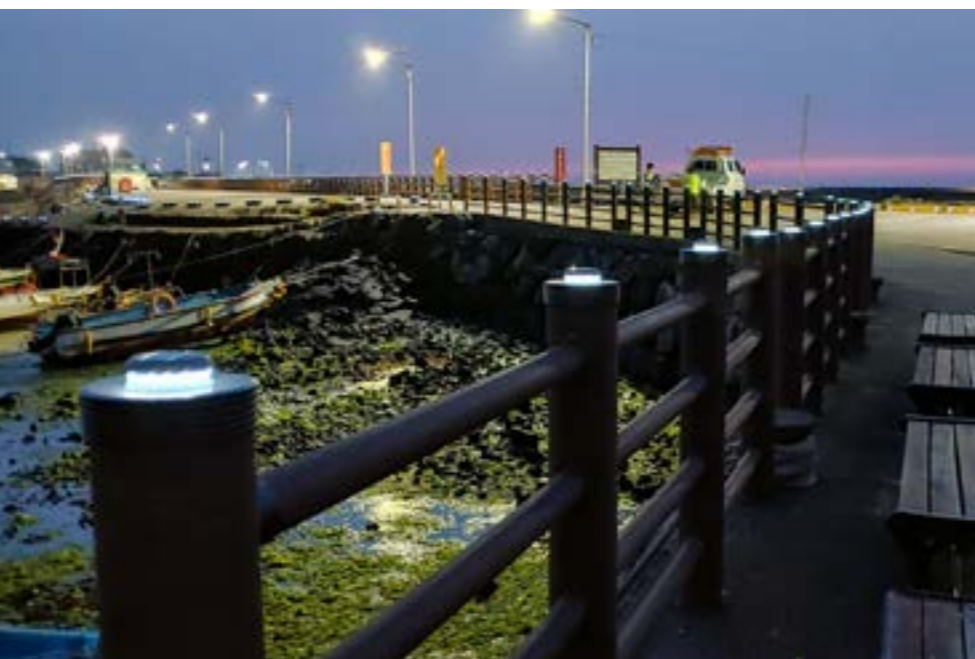

MS-5020 / 5010

태양광 LED바 Solar Lighting Bar

G2B 식별번호

• 단색 /MS-5020 (2M)	• 21824547
• 단색 /MS-5010 (1M)	• 21824548

시공 / Install

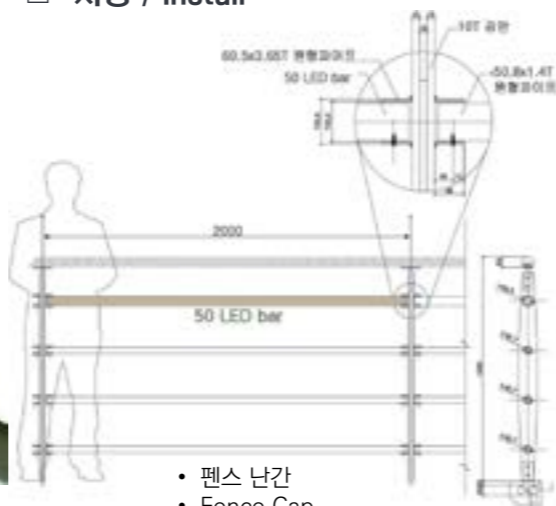

도면 / CAD

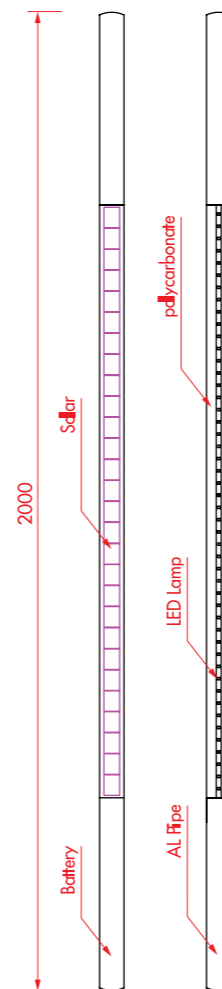

규격 / Specification

* 모델 Model	MS-5020	MS-5010
* 크기 Size	Ø50 × L2000 (2M)	Ø50 × L1000 (1M)
* 무게 Weight	±4.0Kg	±2.0Kg
* 재료 Material	Body : AL-Alloy, PC	
* 방수 W-proof	IP 65	
* 색상 Color	Red. Blue. Green. Yellow. White. Rgb	
* 램프 Lamp	LED Lamp	
* 전원 Power	Solar Powered	
* 점등 On/Off	250~300Lux	



옵션 / Options

• LED 색상.	LED Color
• 점멸/점등.	Steady or Flashing Mode

적용 / Application

- * 육교.다리
- * 산책로
- * 자전거로
- * 공원.테마거리
- * 빌딩조명
- * 야간 거리조명 조성
- * Pedestrian overpass
- * bridge
- * The walks in the area
- * Bike lane
- * Design theme park.
- * Building Lighting
- * Alternative to expensive street lighting

색상 / LED Color



• 백색 /MS-5020 (2M)

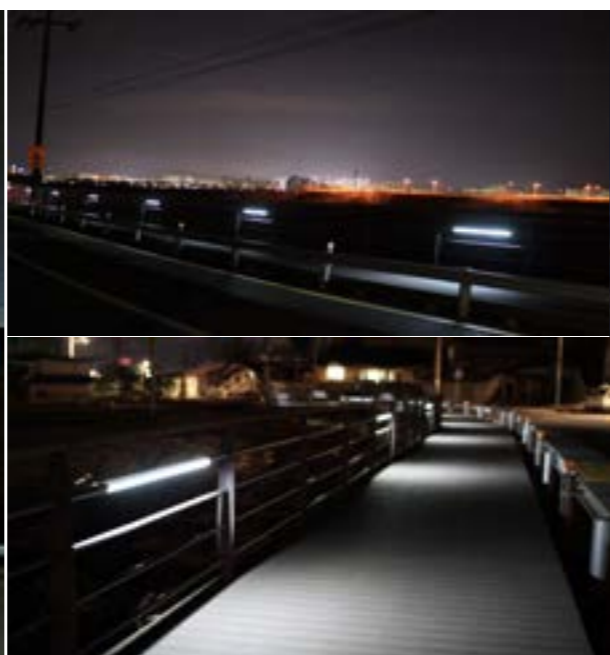
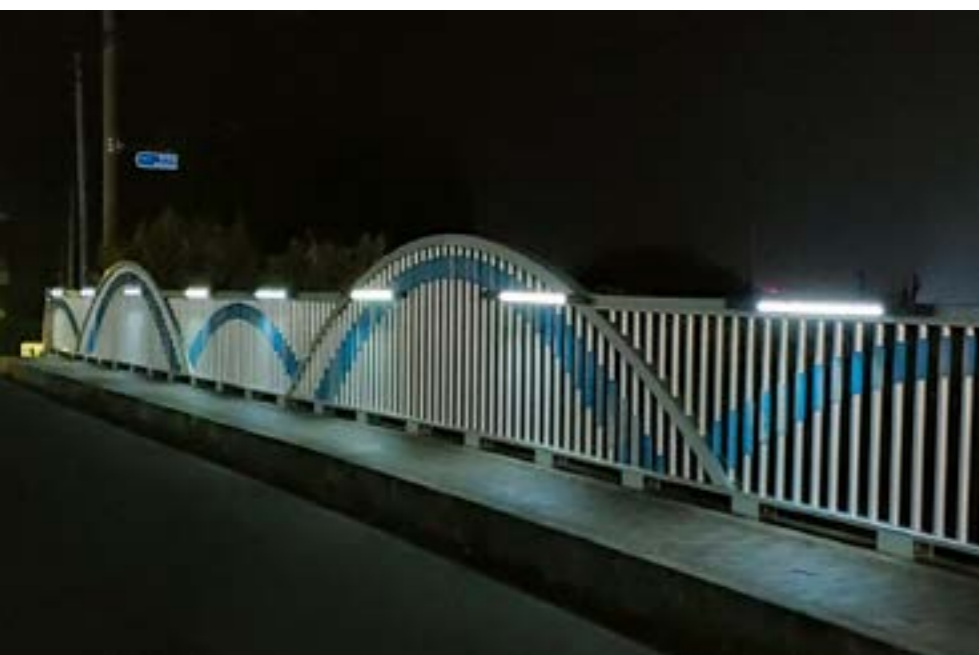

MS-5070

태양광 LED바

Solar Lighting Bar

□ G2B 식별번호

• 단색 /MS-5070	• 22407115
---------------	------------

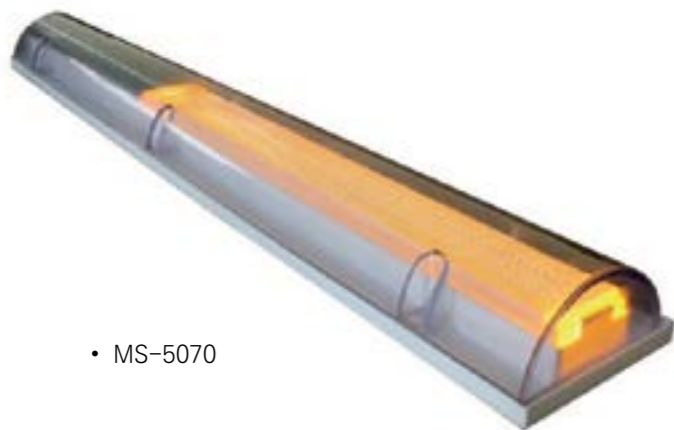

• MS-5070

□ 색상 / LED Color



• Red /Blue /Yellow /Green /White

□ 시공 / Install



- 펜스 난간
- Fence Side

□ 도면 / CAD

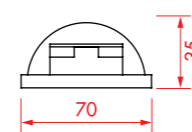
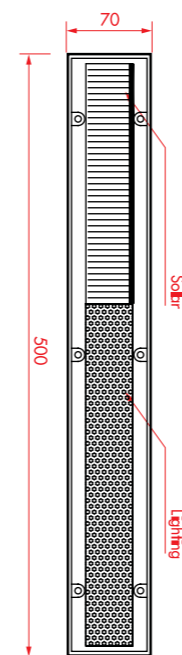

□ 규격 / Specification

* 모델 Model	MS-5070
* 크기 Size	D70 × H35 × L500
* 무게 Weight	±700g
* 재료 Material	Body : PC,STS,
* 방수 W-proof	IP 68
* 색상 Color	Red. Blue. Green. Yellow. White.
* 램프 Lamp	LED Lamp
* 전원 Power	Solar Powered
* 점등 On/Off	250~300Lux



□ 옵션 / Options

• LED색상.	LED Color
• 점멸/점등.	Steady or Flashing Mode

□ 적용 / Application

- * 육교.다리
- * 산책로
- * 자전거로
- * 공원.테마거리
- * 빌딩조명
- * 야간 거리조명 조성
- * Pedestrian overpass bridge
- * The walks in the area
- * Bike lane
- * Design theme park.
- * Building Lighting
- * Alternative to expensive street lighting



MS-260

태양광 스텝등

Solar Beacon Step Lighting

□ G2B 식별번호

• 단색 /MS-260	• 22734711
--------------	------------



□ 색상 / LED Color



• Red /Blue /Yellow /Green /White

□ 도면 / CAD

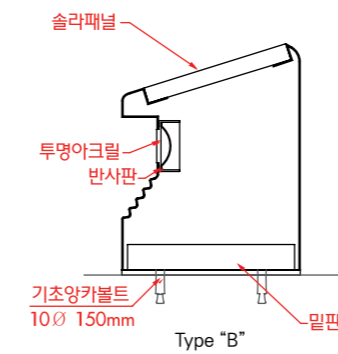
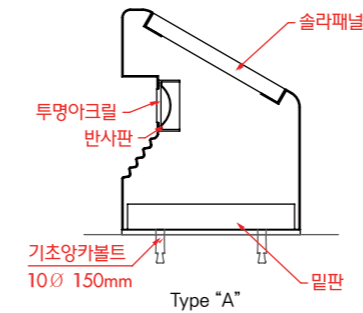
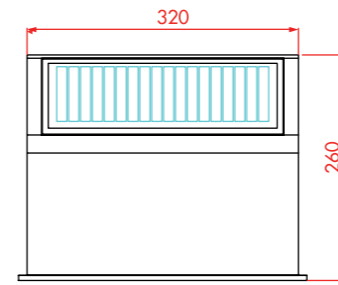

□ 규격 / Specification

* 모델 Model	MS-260
* 크기 Size	D320 × W210 × H260
* 무게 Weight	±8.0Kg
* 재료 Material	Body : Steel & AL
* 방수 W-proof	IP 68
* 색상 Color	Red. Blue. Green. Yellow. White.
* 램프 Lamp	LED Lamp
* 전원 Power	Solar Powered
* 점등 On/Off	250~300Lux



□ 옵션 / Options

• LED색상.	LED Color
• 점멸/점등.	Steady or Flashing Mode

□ 적용 / Application

- * 도로 조명
- * 데크 도로조명
- * 산책로 조명
- * 자전거로
- * 공원.테마거리
- * 야간 거리조명 조성
- * Street Lighting
- * Deck Road Lighting
- * The walks in the area
- * Bike lane
- * Design theme park.
- * Alternative to expensive street lighting



MS-8040

태양광 가로등

Solar Street Lighting

□ G2B 식별번호

• MS-8040 (40W)	• 23070776
• MS-4020 (20W)	• 23070775



• MS-8040
• 40W

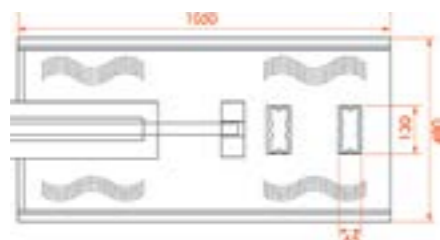

• MS-8040
• 40W

□ 시공 / Install



• 고정용 브라켓트
• BRACKET

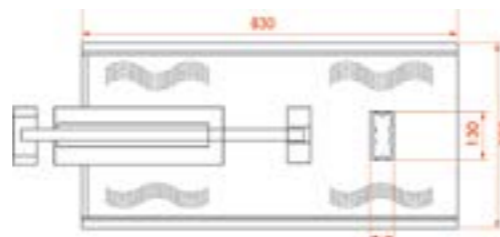

• MS-4020
• 20W

□ 도면 / CAD



□ 규격 / Specification

* 모델 Model	MS-8040	MS-4020
* 크기 Size	1050 × 480 × 50	830 × 320 × 50
* 무게 Weight	±18.0Kg	±12.0Kg
* 램프 Lamp	LED 40W	LED 20W
* 재료 Material	Body : Steel & AL	
* 방수 W-proof	IP 65	
* 색상 Color	White.	
* 전원 Power	Solar Powered	
* 점등 On/Off	250~300Lux	



□ 적용 / Application

- * 도로조명
- * 공원, 테마거리
- * 주차장
- * 우범지역
- * 야간 거리조명 조성
- * Streeting Lighting
- * Design theme park.
- * Parking Lot
- * Prevent crime area
- * Alternative to expensive street lighting



튜브 솔라 [Tube Solar]

Solar Tube Lighting MIRA Series

□ G2B 식별번호

• MIRA-35A



□ 시공 / Install



□ 도면 / CAD

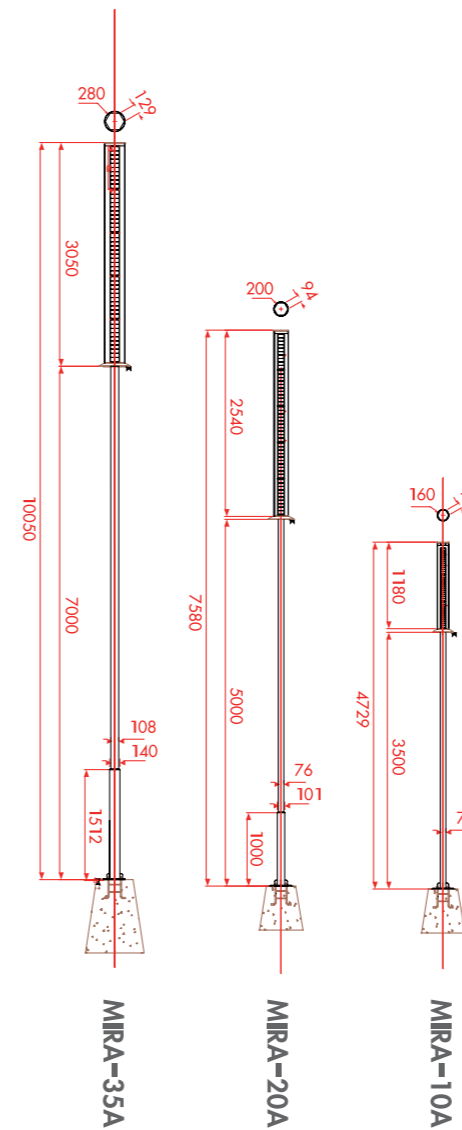

□ 규격 / Specification

* 모델 Model	Mira-Series
* 크기 Size	Ø160 × H1180 / ±15.0Kg /10W
* 무게 Weigh	Ø200 × H2540 / ±35.0Kg /20W
* 램프 Lamp	Ø260 × H3050 / ±35.0Kg /30W
* 재료 Material	Body : Steel & AL
* 방수 W-proof	IP 65
* 색상 Color	White.
* 전원 Power	Solar Powered
* 점등 On/Off	250~300Lux



□ 적용 / Application

- * 도로조명
- * 공원, 테마거리
- * 주차장
- * 우범지역
- * 야간 거리조명 조성
- * Streeting Lighting
- * Design theme park.
- * Parking Lot
- * Prevent crime area
- * Alternative to expensive street lighting



LED 가로등

LED Street Lighting

MS-STC Series

□ G2B 식별번호

•MSJ-ST135A	•22136954
-------------	-----------



•MSJ-ST135A

□ 도면 / CAD

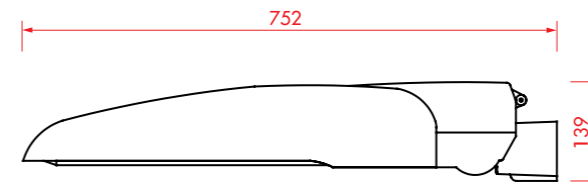
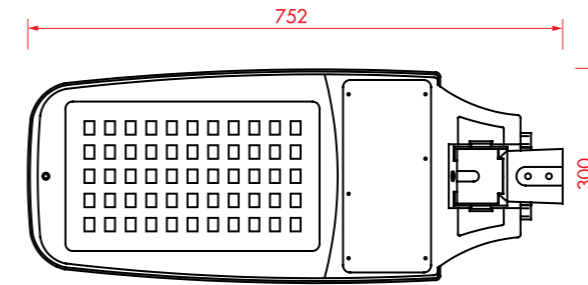

□ 규격 / Specification

* 모델 Model	MS-STC Series
* 크기 Size	D300 × W752 × H139
* 무게 Weight	±10Kg
* 재료 Material	Body : AL-Alloy, PC
* 방수 W-proof	IP 65
* 색상 Color	White (5600~6000K)
* Lumen	W/>9000Lm
* CRI	>90Ra
* 전원 Power	AC85~245V



□ 적용 / Application

- * 도로조명
- * 공원, 테마거리
- * 야간 거리조명 조성
- * Street Lighting
- * Design theme park.
- * Alternative to expensive street lighting

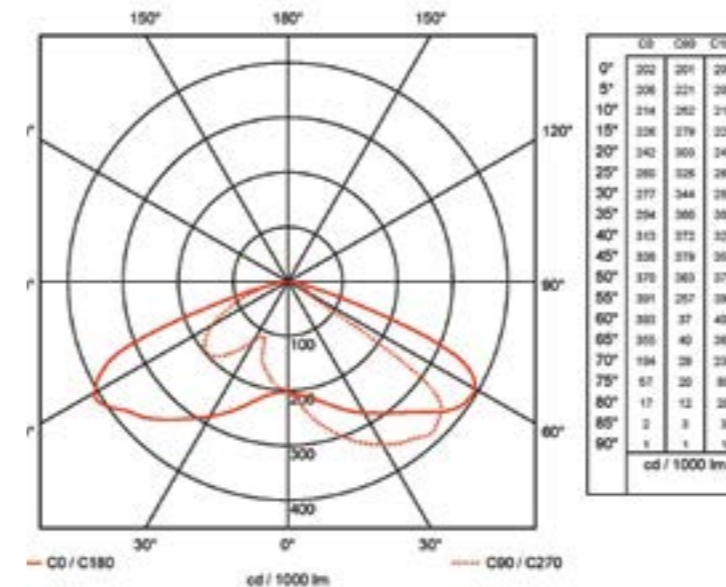

LED 보안등/투광등/공장등

Security /Flood /Industrial Lighting

MS-SCR, MS-FT, MS-ID Series

□ 보안등 MS-SCR60

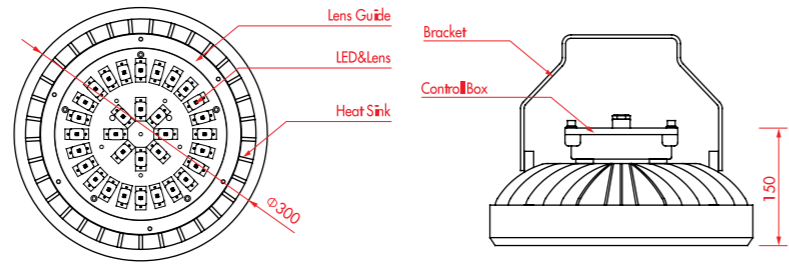

□ 투광등 MS-SCR115

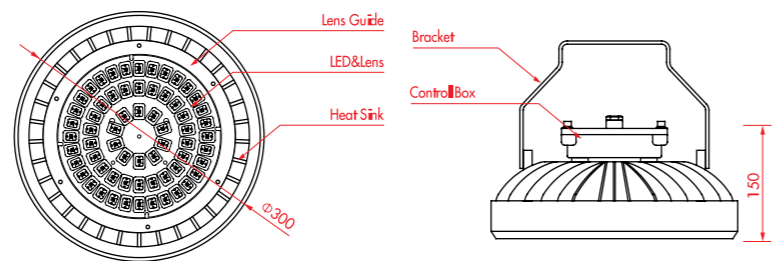

□ 투광등 MS-FT150

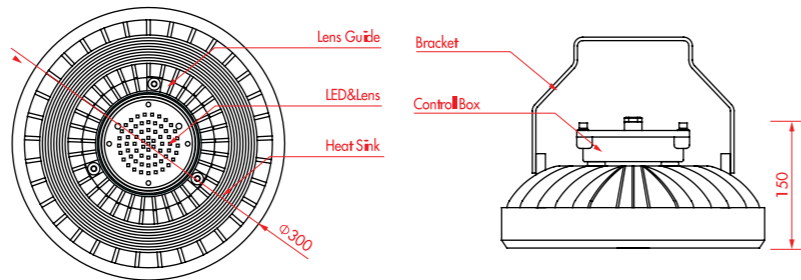

□ 공장등 MS-ID(60W~150W)

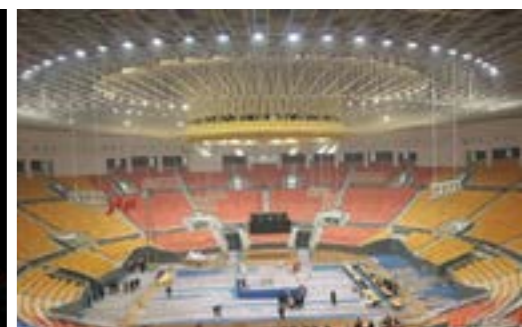
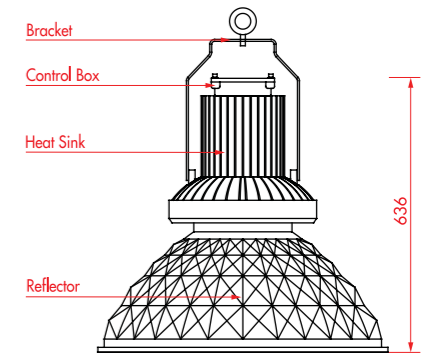
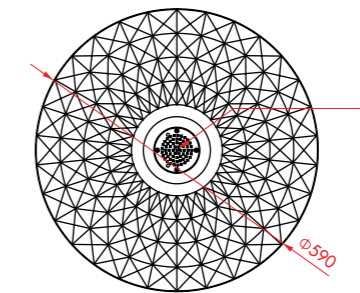
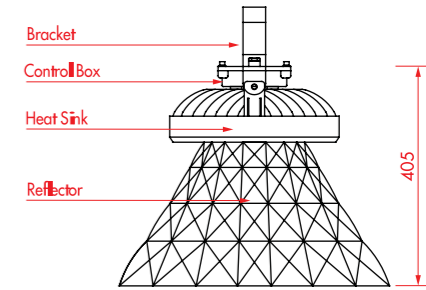
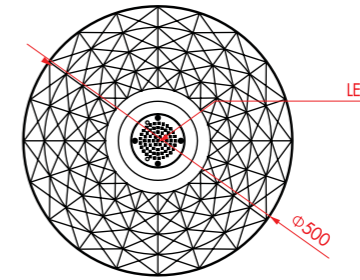

태양광 무선 방범카메라

Solar Wi-fi Security Camera

MS-SE404

□ G2B 식별번호

• CCTV /MS-SE404



- 무전원 / 태양광 전원 사용
- 휴대폰으로 영상확인

□ 시공 / Install



- 벽/지주용 브라켓
- Bracket



□ 도면 / CAD

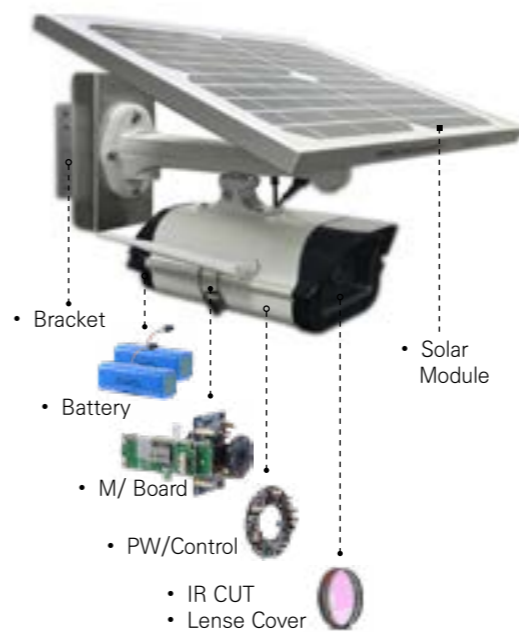

□ 규격 / Specification

* 모델 Model	MS-SE404
* Processor	32bit RISC Processor/Embedded Linux
* 센서 Sensor	1/2.9", 2.43M progressive scan CMOS
* 렌즈 Lense	6mm(F1.8) Fixed Lens,
* 영상 Codec	Triple Stream H.265 / H.264 / M-JPEG
* 해상도 stream	1920x1080, 1280x1024 1280x720
* 통신 network	LAN/ Ethernet 10/100Base-T(LAN Port) Wi-Fi Interface (IEEE 802.11b/g/n)
* 영상 Viewer	Internet Explorer / FlexWATCH Mobile
* 보안 security	IP(Port) Filtering for Access Level
* 저장 record	SD Card Turn on / off Auto by ambient light from sunset to sunrise (200~250Lux)
* 전원 power	Solar powered
* 저장 battery	Li-ion or Li-FePo4 Battery
* 기타 other	Motion Detection 기능(4 Blocks Motion)
	M-JPEG, H.264, H.265 영상압축방식 지원
	2M (1080p), 30fps 실시간 저장 Triple streaming

□ 옵션 / Options

- 저장 Record daytime / night time
- 전원 Power Solar & hybrid

□ 적용 / Application

- 방범 사각지대 * Prevent crime area
- 여성 안심길 * Protect woman's road
- 우범지역, 공원 * Fly tipping area, Park
- 무단쓰레기 투기지역 * Anti theft System
- 농작물 /농기계 도난지역 * Accent black spot
- 교통사고 다발지역



□ 공장 참고 안전

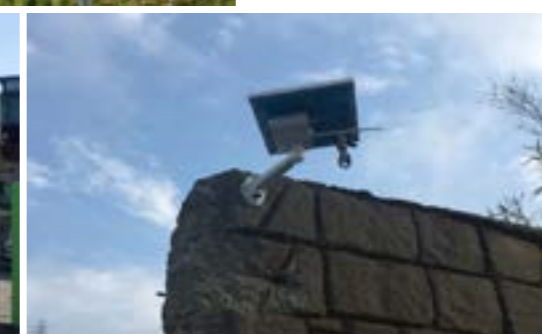

□ 방범용



□ 여성 안심길 안전



□ 양수기등 농기계 도난



□ 인삼밭/과수원등 농작물 감시



□ 쓰레기 불법투기